









Fine grinding and finishing products

Table of contents

General information	4
Quick product selection guide	6
Coated abrasives	8
Surface roughness – influencing factors and reference values	10
Non-woven products	83

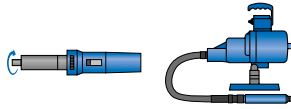
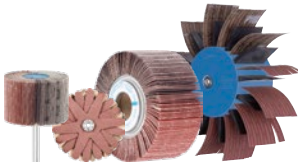
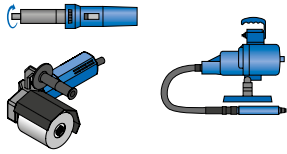
Fine grinding and polishing products

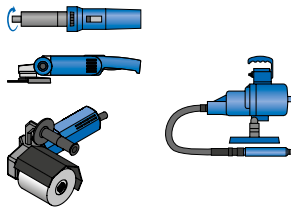
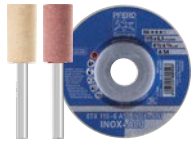
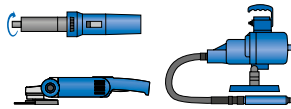
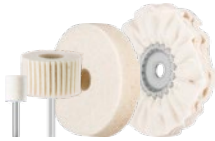
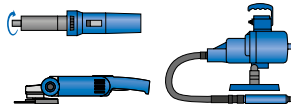
		COMBICLICK® quick-mounting system <ul style="list-style-type: none"> ■ Fibre discs 12 ■ Non-woven discs 15 ■ Felt discs 17 ■ Backing pads 18 ■ Sets 18
		Fibre discs <ul style="list-style-type: none"> ■ Fibre discs 19 ■ Backing pads and accessories 22
		PSA discs <ul style="list-style-type: none"> ■ PSA discs 23 ■ PSA disc holders 24
		Velcro-backed abrasive discs <ul style="list-style-type: none"> ■ NET type 25
		COMBIDISC® quick-change discs <ul style="list-style-type: none"> ■ Abrasive discs 28 ■ Non-woven discs 34 ■ Felt discs 37 ■ Backing pads 37 ■ Sets 38
		Abrasive belts, sheets, and rolls <ul style="list-style-type: none"> ■ File belts 42 ■ Portable belts 43 ■ Belts and accessories for pneumatic drums 44 ■ Benchstand belts 46 ■ Backstand belts 47 ■ POLIVLIES® surface conditioning belts 48 ■ Abrasive sheets 48 ■ POLINOX® hand pads 50 ■ Mandrel 50 ■ Shop rolls and holders 51 ■ Screen rolls 52 ■ Non-woven shop rolls 52 ■ Abrasive cord 53
		Abrasive spiral bands <ul style="list-style-type: none"> ■ Abrasive spiral bands 54 ■ Rubber drum holders 57
		POLIROLL® cartridge rolls <ul style="list-style-type: none"> ■ Cartridge rolls 58 ■ Drive arbors 59

		POLICAP® seamless abrasive caps <ul style="list-style-type: none"> ■ Abrasive caps, cap holders, and sets 62 ■ Abrasive cones and cone holders 68
		Flap wheels <ul style="list-style-type: none"> ■ Mounted flap wheels 69 ■ Quick-change flap wheels and accessories 73 ■ Unmounted flap wheels and accessories 74 ■ Flap wheels for angle grinders and flap drums 77 ■ POLIFLAP® system 79 ■ POLISTAR-TUBE 81
		Non-woven products <ul style="list-style-type: none"> ■ POLINOX® unitized wheels, discs, and arbors 87 ■ POLINOX® convolute wheels and reducing flanges 89 ■ POLINOX® mounted flap wheels 94 ■ POLINOX® cross buffs and accessories 96 ■ POLINOX® unmounted flap wheels and accessories 97 ■ POLINOX® unmounted flap wheels, threaded 98 ■ POLINOX® finishing drums and linear finishing kit 100 ■ POLINOX® fibre-backing discs and high-strength masking tape 102 ■ POLIVLIES® flap discs 103 ■ POLIVLIES® hook and loop discs and holders 104 ■ POLICLEAN® PLUS products 105
		Poliflex® finishing products <ul style="list-style-type: none"> ■ Finishing points – Rubber bond 110 ■ Finishing points – Leather bond 112 ■ Textile wheels 114
		Polishing products <ul style="list-style-type: none"> ■ Felt points 116 ■ Mounted felt flap wheels 117 ■ Felt wheels and flap discs 118 ■ Cloth rings and drive arbors 119 ■ Buffing drum 120
		Grinding and polishing pastes <ul style="list-style-type: none"> ■ Polishing paste bars and grinding pastes 121 ■ Diamond polishing pastes 122 ■ Cleaning products 123
		X-LOCK quick-change system <ul style="list-style-type: none"> ■ POLIVLIES® flap discs 124

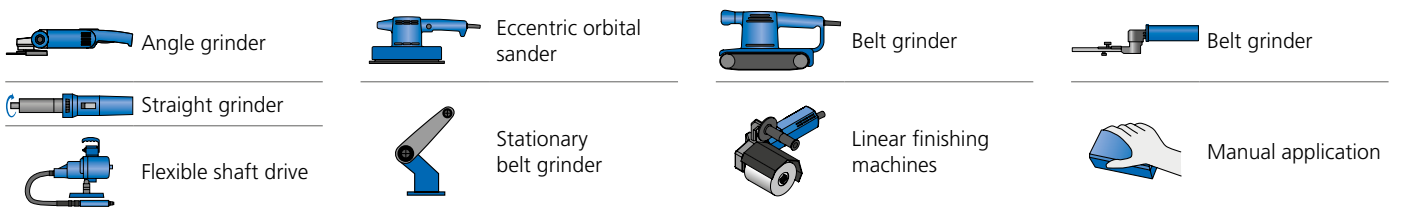

Fine grinding and finishing products

General information



PFERD quality

Fine grinding and finishing products from PFERD are developed, manufactured and tested in accordance with the strictest quality requirements.

Research and development, our in-house and plant construction, and the continuous testing to quality and safety standards in our internal laboratories all guarantee high PFERD quality.

PFERD quality management is certified according to ISO 9001.



Safety notes

Use of the products in this catalogue may create dust and other particles. To avoid any risk of adverse health effects, the operator must use appropriate protective measures, including a respirator, during and after operation. Refer to our Safety Data Sheet (SDS) for further information on how the product should be used.

Furthermore, additional health hazards may result from dust in the surrounding environment and from dust generated from the workpiece material.

PROTECTIVE MEASURES FOR THE OPERATOR MUST ADDRESS DUST AND OTHER PARTICULATES ARISING FROM ALL SOURCES. Always use our products in a well-ventilated workspace.



Technical support

PFERD offers individual targeted support to solve unique application problems. Our experienced sales representatives and technical specialists are available to assist you.

Contact your local sales representative or visit us at pferd.com to learn more.

Products made to order

If you cannot find the solution for your particular application in our extensive catalogue range, we can produce fine grinding and polishing products to meet your requirements in premium PFERD quality specifically for your application upon request.

Contact your local sales representatives who will be happy to assist you.



PFERD packaging

PFERD supplies fine grinding and polishing products in robust industrial packaging, which protects the products against damage. You can find details on the packaging unit (PU) in the product tables. The packaging labels feature easy identification of product features and part number.



PFERD TOOL-CENTER

The **PFERD TOOL-CENTER** is a premium display system that can be custom-designed to meet your specific product and presentation requirements. For more information from a PFERD expert, contact us today at pferd.com.



PFERDPRAXIS brochures and theme brochures

Our **PFERDPRAXIS** brochures contain a wealth of useful information on material properties as well as tips and tricks for using PFERD products on specific materials or for specific applications.



PFERDVALUE® – Your added value with PFERD

Results from the PFERD test laboratories as well as from the product tests by independent testing institutes prove: PFERD products offer measurable added value.

Discover **PFERDERGONOMICS®** and **PFERDEFFICIENCY®**:

As part of **PFERDERGONOMICS®**, PFERD offers ergonomically optimized products and power tools that contribute to greater safety and working comfort, and thus to health protection.



As part of **PFERDEFFICIENCY®**, PFERD offers innovative, high-performance product solutions and power tools with outstanding added value.



For more information on this topic, please refer to our brochure "**PFERDVALUE®** – Your added value with PFERD".

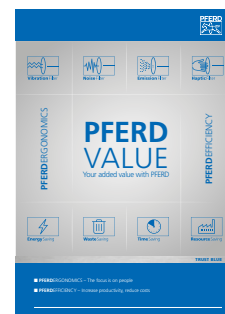











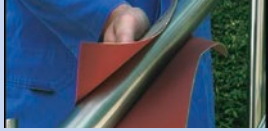





































Please visit our website for more information on our products: pferd.com



Fine grinding and finishing products

Quick product selection guide

Work type	Face-down grinding Products with backing pad		Belt grinding Products for belt grinders							
										
Work steps	Page		Page							
Changing geometrical profiles 	 COMBIDISC® ■ abrasive discs 29–33 ■ diamond abrasive discs 33	 COMBIDISC® mini fibre discs 32	 COMBIDISC® Mini-POLIFAN® 28	 COMBICLICK® fibre discs 13–14	 Fibre discs 20–21	 PSA discs 23–24	 Abrasive belts 42–47			
	Step-by-step fine grinding Reducing roughness depths 	 COMBIDISC® ■ abrasive discs 29–33 ■ non-woven discs 34–36	 Poliflex® finishing wheels 114	 COMBICLICK® ■ fibre discs 13–14 ■ non-woven discs 15–16	 POLINOX® unitized discs 88	 PSA discs 23–24	 Velcro-backed abrasive discs 25	 Fibre discs 20–21	 POLINOX® fibre-backing discs 102	 Abrasive belts 42–47
		Fine grinding Very fine grinding 	 COMBIDISC® ■ abrasive discs 29–33 ■ non-woven discs 34–36	 Poliflex® finishing wheels 114	 POLINOX® unitized discs 88	 Fibre discs 20–21	 PSA discs 23–24	 COMBICLICK® ■ fibre discs 13–14 ■ non-woven discs 15–16	 Abrasive belts 42–47	 Surface conditioning belts 45, 48
Cleaning 			 COMBIDISC® non-woven discs 34–36	 COMBIDISC® POLICLEAN® PLUS discs 34	 COMBICLICK® non-woven discs 15–16	 POLIVLIES® flap discs 103	 POLIVLIES® hook and loop discs 104	 POLICLEAN® PLUS discs 107	 POLINOX® fibre-backing discs 102	 Surface conditioning belts 45, 48
			Creating visual effects 	 COMBIDISC® non-woven discs 34–36	 POLIVLIES® flap discs 103	 POLINOX® fibre-backing discs 102	 POLIVLIES® hook and loop discs 104	 COMBICLICK® non-woven discs 15–16	<td>  Surface conditioning belts 45, 48 </td>	 Surface conditioning belts 45, 48
	Polishing 	 COMBIDISC® felt discs 37		 COMBICLICK® felt discs 17	 Felt flap discs 118	 Felt polishing belt 45				

Peripheral grinding Mounted/unmounted products			Manual grinding		
					
	Page			Page	
	Abrasive spiral bands	55–56			
	POLIROLL® cartridge rolls	59			
	POLICAP® seamless abrasive caps	62–68			
	Abrasive spiral bands	55–56		Unmounted flap wheels for angle grinders	77
	POLIROLL® cartridge rolls	59		Flap drums	78
	POLICAP® seamless abrasive caps	62–68		POLISTAR-TUBE	81
	Mounted flap wheels	71–73		Unmounted flap wheels	75
	POLIROLL® cartridge rolls	59		POLINOX® unitized wheels	87
	POLINOX® convolute wheels	91		Poliflex® fine grinding points	110–113
				Abrasive sheets, cloth/paper	48–49
				Shop rolls, cloth/paper	51
				Screen rolls	52
				Abrasive cord	53
	POLINOX® mounted flap wheels	94–95		POLINOX® finishing drums	100–101
	POLINOX® unmounted flap wheels	97–99		POLICLEAN® PLUS wheels	106
	POLINOX® cross buffs	96		POLICLEAN® PLUS mounted wheels	107
				Abrasive sheets, cloth/paper	48–49
				POLINOX® hand pads	50
				Shop rolls, cloth/paper	51
				Non-woven shop rolls	52
				Screen rolls	52
	POLINOX® mounted flap wheels	94–95		POLIFLAP® grinding wheel	79–80
	POLINOX® unmounted flap wheels	97–99		Flap drums	78
	POLINOX® finishing drums	100–101			
				POLINOX® hand pads	50
				Non-woven shop rolls	52
				High-strength masking tape	102
	Felt points and mounted felt flap wheels	116–117		Buffing drum	120
	Felt wheels	118		Cloth rings	119
				Diamond polishing pastes	122
				Polishing paste bars	121
				INOX SHINER	123
				Grinding pastes	121
				Universal cleaner	123

Fine grinding and finishing products

Coated abrasives

Structure of coated abrasives

PFERD supplies a wide range of products with coated abrasives for machining a variety of workpiece geometries and materials:

- COMBICLICK® quick-mounting system
- Fibre discs
- PSA discs
- Abrasive discs
- COMBIDISC® quick-change discs
- Abrasive belts, sheets and rolls
- Abrasive spiral bands
- POLIROLL® cartridge rolls
- POLICAP® abrasive caps
- Flap wheels

You can find additional PFERD products with coated abrasives in catalogue section 6.

Coated abrasives are used for both wet and dry grinding.

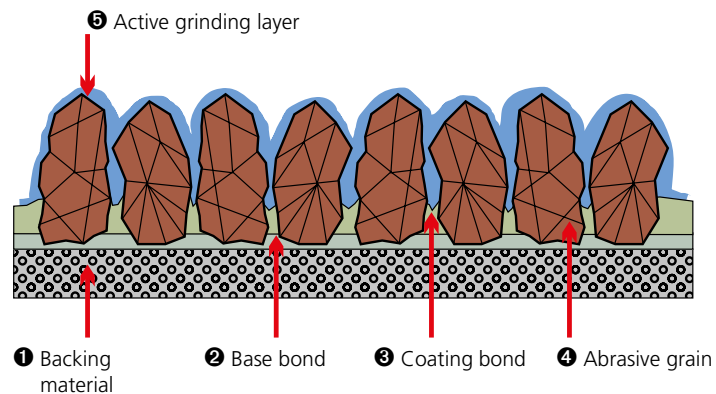

1 Backing material

Bond and abrasive grain are applied to the base. The backing materials available for selection differ in their properties, such as tear strength, flexibility and wear. The respective grinding product is adapted to the requirements of the intended application by choosing the appropriate base material. The PFERD range is sub-divided into three groups:

Paper:

The main areas of application for coated abrasives with a paper base are in the woodworking industry and in trade, e.g. among carpenters, painters and decorators. Coated abrasives with a paper base are rarely used for industrial metalwork. Abrasives for manual grinding are predominantly made from paper with a surface weight of 70 to 100 g/m². Heavier paper types are used to make abrasives for machine applications involving wide and narrow belts alike.

Cloth:

Coated abrasives with a cloth base are predominantly used for metalwork.

Vulcanized fibre:

When adapted to the corresponding applications, vulcanized fibre in various thicknesses is predominantly used for making fibre grinding discs. Vulcanized fibre is a very sturdy, robust backing material, and also very wear-resistant.

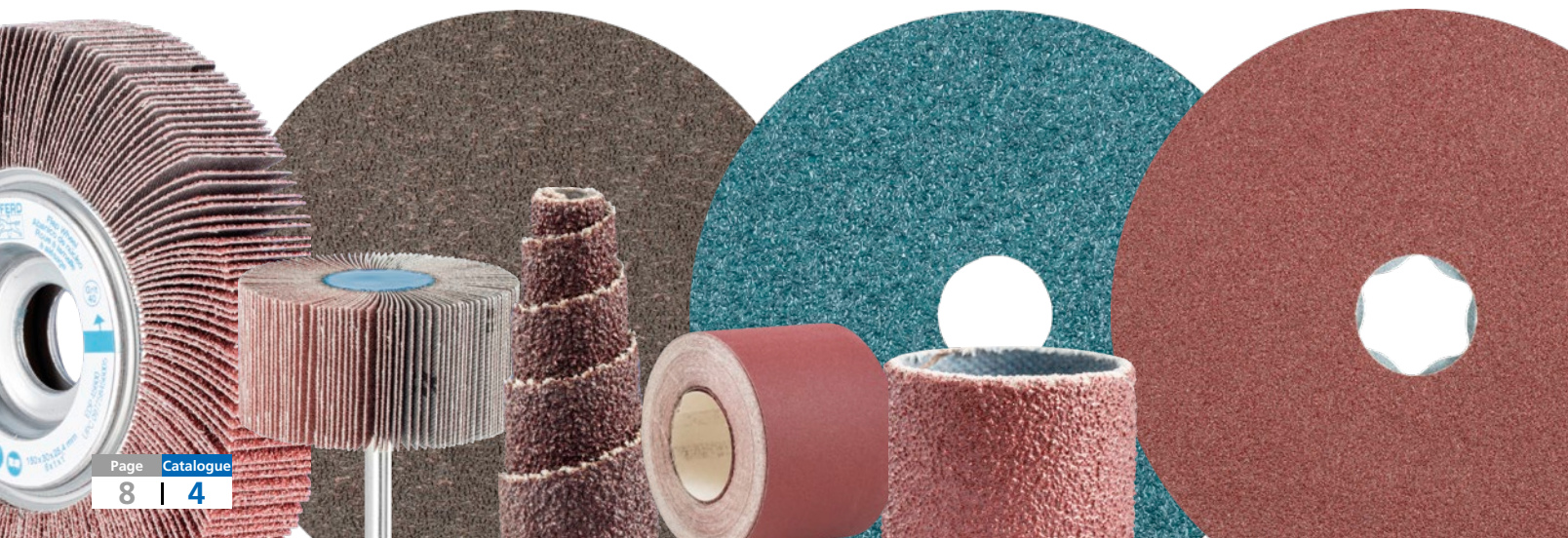

2 + 3 Bond

When manufacturing coated abrasives, different resin bonds are used to fix the abrasive grain to the backing material. First, the backing material is coated with the base bond (2). After this, the abrasive grain is evenly scattered over the surface and aligned to achieve higher aggressiveness with the help of special procedures. The coating bond (3) ensures that the abrasive grain is fixed in place and protects the grain against the forces and loads resulting from the grinding process.

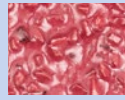
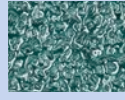

4 Abrasive grain

Choosing the right abrasive grain has a significant influence on surface quality and productivity. The most common materials for abrasive grain are:

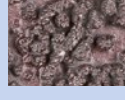
Aluminum oxide A		<p>Numerous types of aluminum oxide are used as abrasives. These may be present in molten or sintered form. The hardness and toughness can be influenced by special manufacturing procedures or additives. Standard types of aluminum oxide and a "sharp-edged" grain shape are predominantly used for coated abrasives.</p>
Ceramic oxide CO		<p>For sintered aluminum oxides, a differentiation is made between sintered bauxite aluminum oxides and sol-gel aluminum oxides. Sol-gel aluminum oxides are predominantly used for coated abrasives in the form of abrasive ceramic grain. This state-of-the-art abrasive is used for numerous applications due to its high toughness and good self-sharpening qualities.</p>
Zirconia alumina Z		<p>Zirconia alumina is a fused mixture of aluminum oxide and zirconium oxide. In comparison to aluminum oxides, zirconia alumina exhibits lower hardness but greater toughness. The high proportion of zirconium oxide results in an extremely powerful self-sharpening effect and contributes to outstanding stock removal rates with cool grinding and a long service life.</p>
Silicon carbide SiC		<p>Silicon carbide is synthetically manufactured abrasive grain which has very sharp edges, with low toughness and very high hardness. It is recommended for work on titanium, aluminum, bronze, stone and plastics. Ideally suited for use in the aeronautical industry, especially where SiC is the only approved abrasive, e.g. for use on engine components.</p>
Diamond grain D		<p>Diamond grain is the hardest abrasive. It consists of pure carbon in a crystalline structure. For grinding products, the diamonds used are generally synthetic, produced at very high temperatures and under high pressure. The properties of diamond grain can be adapted for use in grinding products through various synthesis conditions.</p>
Compact grain CK		<p>In the case of compact grain, individual grains are built up as granulate with a bond system. Each individual grain of granulate is one solid unit, in which numerous abrasive grains made from aluminum oxide or silicon carbide (SiC) are joined together. Used abrasive grains are torn out of this compound structure by the forces resulting from the grinding, and expose sharp abrasive points in doing so. This guarantees a long service life with a constant surface quality.</p>

Grit sizes

The various grit sizes for coated abrasives are specified in ISO 6344 and have been adopted for FEPA standards:

Coarse	Medium	Fine	Superfine
P 12 – 16 – 20 – 24 – 36 – 40 – 50 – 60 – 80	P 100 – 120 – 150 – 180 – 220 – 240 – 280	P 320 – 360 – 400 – 500 – 600	P 800 – 1000 – 1200 – 1500

5 Active grinding layer

The use of an active grinding layer considerably increases the stock removal rate and reduces the workpiece temperature. This is especially advantageous for materials with poor heat-conducting properties, such as stainless steel (INOX). PFERD products with an active grinding layer feature the additional "COOL" label in their item description.



Fine grinding and finishing products

Surface roughness – influencing factors and reference values

Factors influencing surface roughness:

Abrasive:

- The larger the grit, the rougher the surface finish will be.
- Aluminum oxide, ceramic oxide and zirconia alumina grains all achieve similar levels of surface roughness.
- Workpieces which are ground with silicon carbide grain exhibit a slightly brighter or more reflective surface than other grains.

Workpiece materials:

- The softer the material to be ground, the coarser the finished surface will be when using the same grit sizes.
- Adding grease or lubricant will achieve a slightly finer surface finish.

Work parameters:

- The relationship between the peripheral speed and feed rate has the following impact:
 - Increasing the peripheral speed slightly improves the surface quality.
 - Reducing the speed of the feed rate makes the surface quality slightly finer.
- The contact pressure can have a significant influence on the surface roughness.

There is a differentiation between the following roughness depths:

The **individual roughness depth** R_{z1} is the sum of the height of the largest profile peak and the depth of the largest profile trough within an individual measuring section.

The **roughness depth** R_z is the largest individual roughness depths (R_{z1}) of consecutive individual measuring sections.

The **roughness depth** R_{max} is the largest individual roughness depth within the overall measuring section.

The **average roughness value** R_a is the arithmetic mean value of the sum of all profile values within the roughness profile.

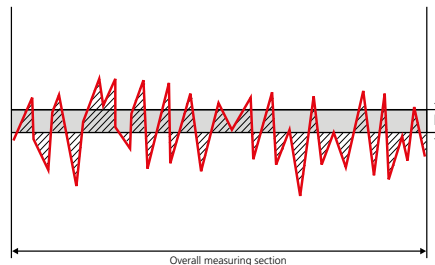
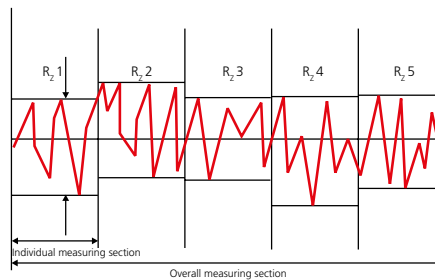

Reference values for roughness depths in the case of different applications

Application	Roughness depth
Coarse stock removal: Grit sizes 24 to 150	$R_a = 0.70$ to $12 \mu\text{m}$ (25 to $470 \mu\text{in}$)
Fine finishing: Grit sizes 180 to 400	$R_a = 0.20$ to 0.70 (8 to $25 \mu\text{in}$)
Very fine finishing: Grit sizes 500 to 1200	$R_a = 0.05$ to $0.20 \mu\text{m}$ (2 to $8 \mu\text{in}$)
Mirror finishing: Step 1:	$R_a = 0.10$ to $0.20 \mu\text{m}$ (4 to $8 \mu\text{in}$)
Step 2:	$R_a = 0.04$ to 0.10 (2 to $4 \mu\text{in}$)
Step 3:	$R_a < 0.01 \mu\text{m}$ ($< 1 \mu\text{in}$)
Pharmaceutical grade:	$R_a = 0.20$ to $0.70 \mu\text{m}$ (8 to $25 \mu\text{in}$)
Sanitary food grade/ directional matte finish:	$R_a = .10$ to $0.70 \mu\text{m}$ (4 to $25 \mu\text{in}$)

Surface roughness of different materials after machining with products using coated abrasives

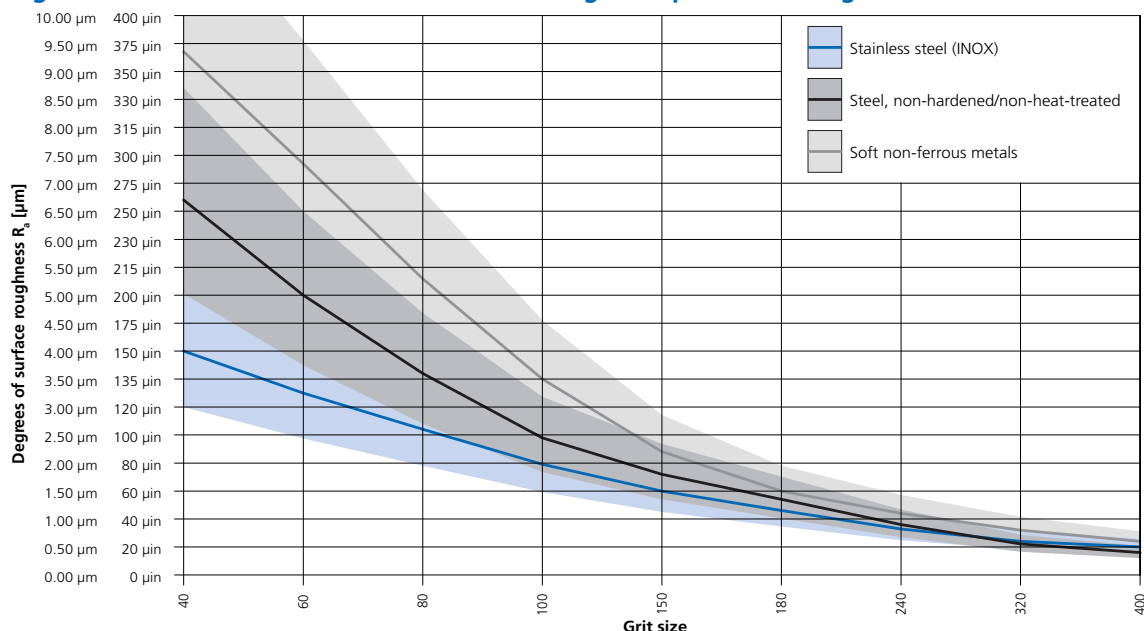

The patented quick-mounting and cooling system is recommended with fibre, non-woven and felt discs.

The COMBICLICK® system consists of a specially developed backing pad and a rugged mounting system at the back of the disc. The backing pad allows COMBICLICK® discs to be used on most available angle grinders.

The special geometry of the cooling slots ensures high air throughput, which considerably reduces the thermal load on the abrasive material and the workpiece.

The quick-mounting system, rugged fixture, secure attachment of the disc and optimized cooling system help to provide up to 30% lower workpiece temperature, up to 25% increased stock removal, up to 30% longer disc life and improved utilization of the abrasive.

Lower process costs and workpiece temperature

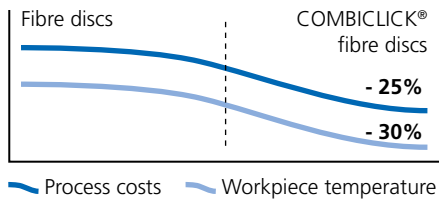

Higher stock removal rate

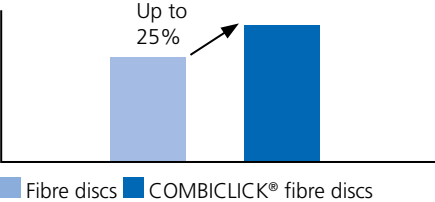

Longer service life

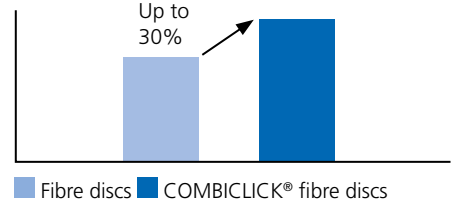

Advantages:

System



Very easy and comfortable.

Clamping mounting system



Extremely fast and easy disc changing reduces process costs.

Cooling effect

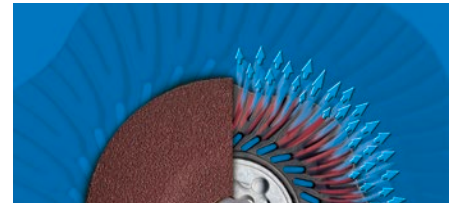

Very good cooling of the disc and workpiece.

Flexible grinding



Soft and flexible grinding performance in face-down grinding with 5 inch diameter fibre discs.

COMBICLICK® allows a very flat grinding angle!



With COMBICLICK®, scratches caused by protruding clamping parts are prevented and very high utilization of the available abrasive is attained.



PFERDVALUE®

PFERDERGONOMICS® recommends COMBICLICK® as an innovative product solution to sustainably reduce vibration, noise and dust levels produced by discs, and to improve working comfort.



PFERDEFFICIENCY® recommends COMBICLICK® for long, fatigue-free and resource-saving work in the shortest possible time. The patented quick-mounting system reduces disc changes and setup times.



COMBICLICK® quick-mounting system

Fibre discs

The wide range of COMBICLICK® fibre discs offers the best product for any grinding application, from coarse to fine.

Advantages:

- Innovative quick-mounting system guarantees convenient handling and cool grinding.
- High productivity due to long service life and very high stock removal rate.
- Consistent surface finish resulting from high-quality abrasives.

Applications:

- Leveling
- Deburring
- Surface work
- Work on edges
- Work on weld seams
- Step-by-step fine grinding

Recommendations for use:

- Use COMBICLICK® fibre discs with COMBICLICK® backing pads on commercially available angle grinders.

Compatible power tools:

- Angle grinders
- Cordless angle grinders

Ordering notes:

- Order COMBICLICK® backing pads separately. Detailed information and ordering data for backing pads can be found on page 18.

Safety notes:

- The maximum permitted peripheral speed is 15,800 SFPM.
- For safety reasons, it is imperative to remain within the stated maximum permitted rotational speed at all times.

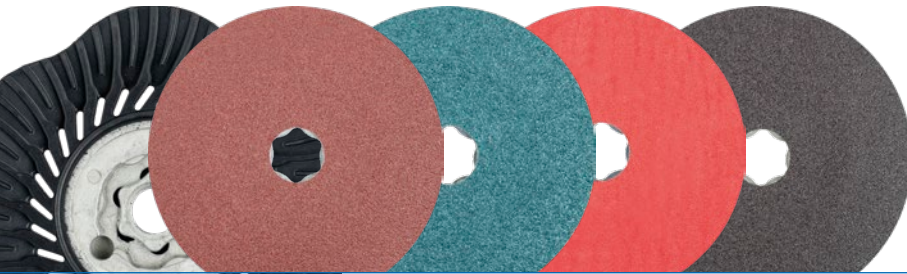

Quick product selection guide

Material group ▼		Abrasive ▶	Aluminum oxide A	Zirconia Alumina Z	Ceramic oxide CO	Silicon carbide SiC	Aluminum oxide A-COOL	Ceramic oxide CO-COOL
Steel, cast steel	Non-hardened, non-heat-treated steels	Construction steels, carbon steels, tool steels, non-alloyed steels, cast steel	●	○	●			
	Hardened, heat-treated steels	Tool steels, tempering steels, alloyed steels, cast steel	○	●	●			
Stainless steel (INOX)	Rust- and acid-resistant steels	Austenitic and ferritic stainless steels		○			●	●
Non-ferrous metals	Soft non-ferrous metals, non-ferrous metals	Soft aluminum alloys	○				●	○
		Brass, copper, zinc	●	○	○			
	Hard non-ferrous metals	Hard aluminum alloys	●	○	○	○		
		Bronze, titanium		○	○	●		●
	High-temperature-resistant materials	Nickel-based and cobalt-based alloys		○	○			●
Cast iron	Grey cast iron, white cast iron	Cast iron with flake graphite, with nodular graphite cast iron, white annealed cast iron, black cast iron	●	○	●			
Plastics, other materials		Fibre-reinforced plastics, thermoplastics, wood, chipboard, paintwork	●			●		

● = highly recommended

○ = recommended

Aluminum oxide A

For universal grinding work from coarse to fine grinding in industry and professional trades.

Abrasive:

Aluminum oxide A

Ordering notes:

■ Please order COMBICLICK® backing pad separately.

PFERDVALUE®:

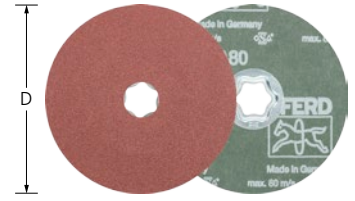
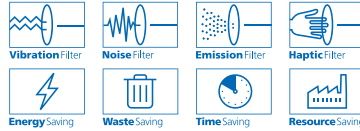

D [Inches]	Grit and EDP number						Max. RPM	
	24	36	50	60	80	120		
4-1/2	40091	40092	40093	40094	40095	40097	13,300	25
5	40099	40100	40101	40102	40103	40105	12,200	25

Zirconia alumina Z

For coarse grinding work with a high stock removal rate and a long service life.

Abrasive:

Zirconia alumina Z

Recommendations for use:

■ Use powerful angle grinders in the case of a higher contact pressure.

Ordering notes:

■ Please order COMBICLICK® backing pad separately.

PFERDVALUE®:

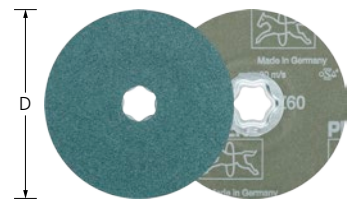
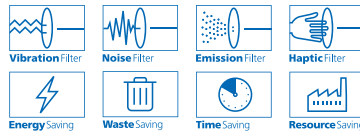

D [Inches]	Grit and EDP number						Max. RPM	
	24	36	50	60	80	120		
4-1/2	-	40131	40132	40133	40134	40136	13,300	25
5	40137	40138	40139	40140	40141	40143	12,200	25

Ceramic oxide CO

For aggressive grinding with a very high stock removal rate and very long service life. The ceramic oxide grain is specifically designed for work on hard materials and coatings.

Abrasive:

Ceramic oxide CO

Recommendations for use:

■ Use with high-powered angle grinders.

Ordering notes:

■ Please order COMBICLICK® backing pad separately.

PFERDVALUE®:

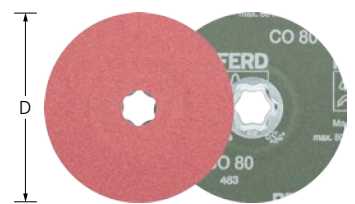
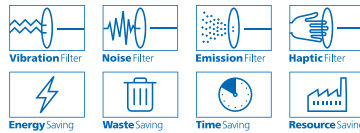

D [Inches]	Grit and EDP number						Max. RPM	
	24	36	50	60	80	120		
4-1/2	40697	40698	40699	40700	40701	40703	13,300	25
5	40704	40705	40706	40707	40708	40710	12,200	25



COMBICLICK® quick-mounting system

Fibre discs

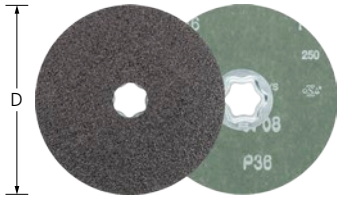

Silicon carbide SiC

For universal grinding work on components made from aluminum, copper, bronze, titanium and fibre-reinforced plastics.

Recommended for use on titanium alloys.

Ideally suited for use in the aerospace industry, especially where SiC is the only approved abrasive, e.g. for use on engine components.

Abrasive:
Silicon carbide SiC

Ordering notes:
■ Please order COMBICLICK® backing pad separately.

PFERDVALUE®:

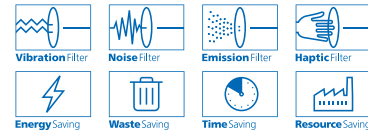

D [Inches]	Grit and EDP number				Max. RPM	
	36	60	80	120		
4-1/2	40021	40022	40023	40024	13,300	25
5	40028	40029	40030	40031	12,200	25



Aluminum oxide A-COOL

For universal grinding work from fine to very fine grinding on materials that do not conduct heat well, e.g. stainless steel (INOX) and aluminum.

Active grinding additives in the coating substantially improve the stock removal rate, prevent loading and result in cooler grinding.

Abrasive:
Aluminum oxide A-COOL

Ordering notes:
■ Please order COMBICLICK® backing pad separately.

PFERDVALUE®:

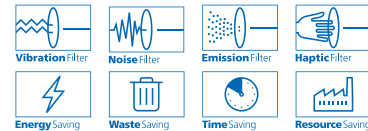

D [Inches]	Grit and EDP number							Max. RPM	
	50	60	80	120	150	180	220		
4-1/2	-	40302	40303	40305	40306	-	40308	13,300	25
5	40310	40311	40312	40314	40315	40316	40317	12,200	25

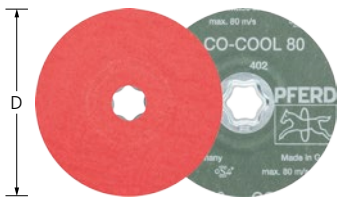

Ceramic oxide CO-COOL

For aggressive grinding with maximum stock removal rate on hard materials that do not conduct heat well. Consistently high performance due to self-sharpening ceramic oxide grain.

Active grinding additives in the coating substantially improve the stock removal rate, prevent loading and result in cooler grinding.

Abrasive:
Ceramic oxide CO-COOL

Ordering notes:
■ Please order COMBICLICK® backing pad separately.

PFERDVALUE®:

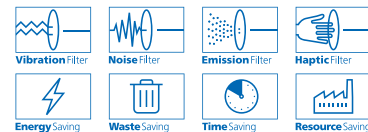

D [Inches]	Grit and EDP number						Max. RPM	
	24	36	50	60	80	120		
4-1/2	40725	40726	40727	40728	40729	40731	13,300	25
5	40732	40733	40734	40735	40736	40738	12,200	25
7	40746	40747	40748	40749	-	-	8,500	25

COMBICLICK® non-woven discs are used for face-down grinding. They are available in the following types: finishing-soft type, surface conditioning-hard type, and unitized.

Advantages:

- Innovative quick-mounting system guarantees convenient handling and cool grinding.

Workpiece materials:

- Can be used on nearly all materials.

Applications:

- Roughing
- Deburring
- Surface work
- Cleaning
- Work on weld seams
- Structuring surfaces
- Step-by-step fine grinding

Recommendations for use:

- Use COMBICLICK® non-woven discs with COMBICLICK® backing pads on variable speed angle grinders.

Compatible power tools:

- Angle grinders
- Cordless angle grinders

Ordering notes:

- Order COMBICLICK® backing pads separately. Detailed information and ordering data for backing pads can be found on page 18.

Safety notes:

- For safety reasons, it is imperative to remain within the stated maximum permitted rotational speed at all times.



Non-woven discs



Surface conditioning, hard type

Recommended for universal work on small and medium-sized metal surfaces, e.g. removing rough grinding traces, removing oxidation and light deburring work. Achieve matte and satin-finished surfaces.

Advantages:

- Little wear due to high tear strength.
- The open structure of the non-woven material prevents loading.

Abrasive:

Aluminum oxide A

Available POLIVLIES® grit sizes:

100 C = coarse (yellow-brown)

180 M = medium (red-brown)

240 F = fine (blue)

Recommendations for use:

- COMBICLICK® surface conditioning, hard type discs achieve their best performance at a recommended peripheral speed of 3,000–4,000 SFPM. This provides an ideal compromise between stock removal rate, surface quality, thermal load on the workpiece and disc wear.

- The addition of oil or water during grinding results in a finer finish, cooler grinding and longer service life.

Ordering notes:

- Please order COMBICLICK® backing pad separately.

PFERDVALUE®:

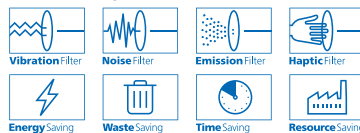

D [Inches]	Grit and EDP number			Opt. RPM	Max. RPM	
	100 C	180 M	240 F			
4-1/2	48100	48101	48103	3,300	10,500	10
5	48110	48111	48113	3,100	9,650	10

COMBICLICK® quick-mounting system

Non-woven discs

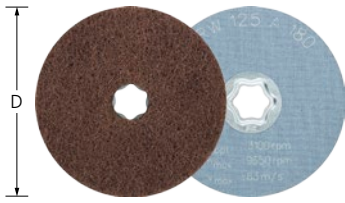

Finishing, soft type

Recommended for very fine grinding on small and medium-sized surfaces and contours, and for cleaning metal and painted surfaces. Achieve matte and satin-finished surfaces. Highly open structure.

Advantages:

- Can be used for wet and dry grinding.
- The open structure and high flexibility of the non-woven material prevents loading.

Abrasive:

Aluminum oxide A
Available POLINOX® grit sizes:
100 = medium
180 = fine
280 = very fine

Ordering notes:

- Please order COMBICLICK® backing pad separately.

PFERDVALUE®:

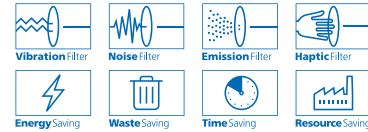

Recommendations for use:

- COMBICLICK® finishing, soft type discs achieve their best performance at a recommended peripheral speed of 3,000–4,000 SFPM. This provides an ideal compromise between stock removal rate, surface quality, thermal load on the workpiece and disc wear.

D [Inches]	Grit and EDP number			Opt. RPM	Max. RPM	
	100	180	280			
4-1/2	48131	48132	48133	3,300	10,500	10
5	48135	48136	48137	3,100	9,650	10



Unitized discs

For achieving a very fine, uniform surface finish which, depending on requirements, is a sufficient preparation for high-gloss polishing. Recommended for work on larger surfaces on components made of stainless steel (INOX).

The different thicknesses/hardnesses of the non-woven material are colour-coded:

W (soft) = grey, MW (medium-soft) = light blue, MH (medium-hard) = dark blue, H (hard) = red

Advantages:

- High edge strength due to extreme durability.
- Can be profiled as desired, enabling optimal adjustment to the contour.

Abrasive:

Aluminum oxide A
Silicon carbide SiC

Ordering notes:

- Further information on unitized products can be found on pages 85–86.

PFERDVALUE®:

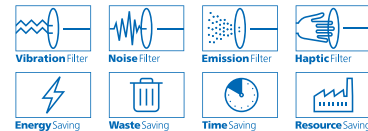

Recommendations for use:

- COMBICLICK® unitized discs achieve their best performance at a recommended peripheral speed of 3,000–6,900 SFPM.

D [Inches]	Abrasives	Grit size	Hardness	Spec	EDP number	Opt. RPM	Max. RPM	
4-1/2	SiC	fine	W	2SF	48150	5,000	8,350	5
	SiC	fine	MW	3SF	48154	5,000	8,350	5
	SiC	fine	MH	6SF	48158	5,000	8,350	5
	A	fine	H	8AM	48162	5,000	8,350	5
5	SiC	fine	W	2SF	48166	4,500	7,650	5
	SiC	fine	MW	3SF	48170	4,500	7,650	5
	SiC	fine	MH	6SF	48174	4,500	7,650	5
	A	fine	H	8AM	48178	4,500	7,650	5

COMBICLICK® felt discs are used for face-down grinding on medium-sized and large surfaces. They are supplied in various diameters.

Advantages:

- Innovative quick-mounting system guarantees convenient handling with fast disc changes.

Workpiece materials:

- Can be used on nearly all materials.

Applications:

- Polishing

Recommendations for use:

- Use COMBICLICK® felt discs with COMBICLICK® backing pads on variable speed angle grinders.
- Felt discs achieve their best performance at a recommended peripheral speed of 1,000–2,000 SFPM. This provides an ideal compromise between polishing performance, thermal load on the workpiece and disc wear.
- When changing the polishing paste, employ a new, unused felt disc.

Compatible power tools:

- Angle grinders
- Cordless angle grinders

Ordering notes:

- Please order COMBICLICK® backing pads separately. More detailed information and ordering data for backing pads can be found on page 18.
- Please order grinding and polishing pastes separately. Detailed information and ordering data for grinding and polishing pastes can be found on pages 121–122.

Safety notes:

- For safety reasons, it is imperative to remain within the stated maximum permitted rotational speed at all times.



Felt discs

4

Felt discs

Recommended for polishing with polishing paste bars, grinding pastes or diamond polishing pastes in face-down grinding on medium-sized and large surfaces.

Advantages:

- High productivity due to very long service life.
- Consistent performance over the entire lifespan due to high dimensional stability.

PFERDVALUE®:

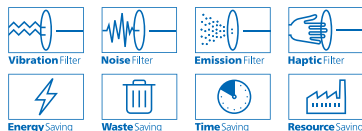

D [Inches]	EDP number	Opt. RPM	Max. RPM	
4-1/2	48705	1,900	10,500	5
5	48706	1,650	9,650	5

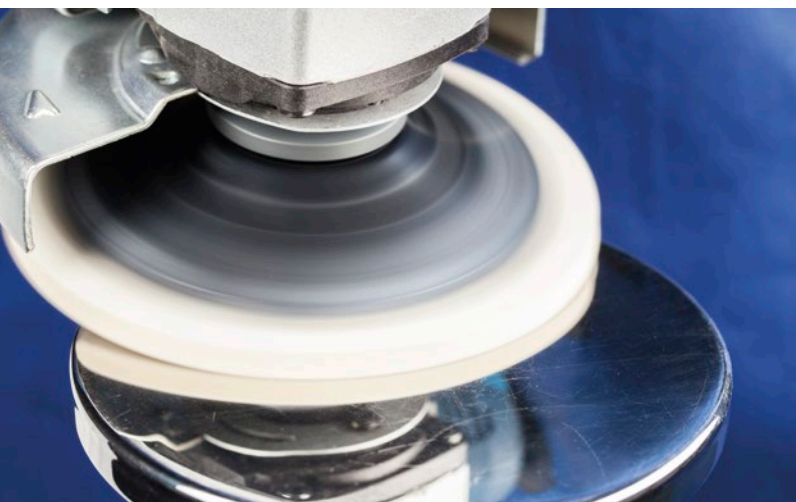

COMBICLICK® quick-mounting system

Backing pads



Backing pads

With this backing pad, COMBICLICK® discs can be used on commercially available angle grinders. The different hardnesses are colour-coded:

CC-GT (medium) = black
CC-H-GT (hard) = blue

Advantages:

- The geometry of the cooling slots significantly reduces the thermal load.
- High productivity due to minimized disc change times.

Recommendations for use:

- CC-H-GT backing pads is mainly used to work on stainless steel (INOX). It features very high edge strength, which enables a higher contact pressure.

Safety notes:

- The maximum approved peripheral speed is 15,800 SFPM.
- For backing pads with a 7 inch diameter, do not apply too high a contact pressure in order to prevent the backing pad from overstretching.

PFERDVALUE®:

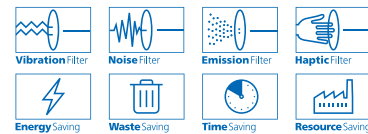

Disc diameter [Inches]	Thread	Hardness	EDP number	Max. RPM	
4-1/2 and 5	5/8-11	medium	69470	13,300	1
		hard	69478	13,300	1
7	5/8-11	medium	69474	8,500	1

Sets



COMBICLICK® sets

COMBICLICK® sets include a wide variety of coated and non-woven materials to test performance and surface finish results to help determine the right product selections for your applications prior to bulk purchases.

The included discs provide solutions for rough grinding, fine grinding, surface conditioning, prepolish and polishing to a mirror finish.

Contents:

- 3 pcs. each of COMBICLICK® fibre discs:
 - CO-COOL 36 grit
 - CO-COOL 120 grit
 - A-COOL 220 grit
- 1 pc. each of COMBICLICK® non-woven disc:
 - Surface conditioning, hard type, 240 F fine
 - Surface conditioning, hard type, 180 M medium
 - Surface conditioning, hard type, 100 C coarse
 - Finishing, soft type, 280 very fine
 - Finishing, soft type, 180 fine
 - Finishing, soft type, 100 medium
 - Unitized disc SiC W soft
- 1 pc. each of:
 - Universal polishing paste
 - COMBICLICK® felt disc
 - COMBICLICK® backing pad
 - CC-GT 5/8-11

Advantages:

- Getting to know and testing the comprehensive system.
- Coordinated selection of the most common products.

Abrasive:

Aluminum oxide A
Ceramic oxide CO-COOL
Silicon carbide SiC

PFERDVALUE®:

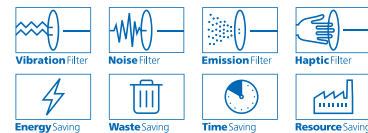

D [Inches]	Thread	EDP number	
4-1/2	5/8-11	48192	1
5	5/8-11	48194	1

The extensive range of fibre discs provides the optimum product for any machining application, from coarse to fine grinding. PFERD provides fibre discs with various grit sizes, abrasives and dimensions. In accordance with ISO 16057, PFERD fibre discs are manufactured in shape A2, type F, and designated "vulcanized fibre discs".

Advantages:

- High productivity due to long service life and very high stock removal rate.
- Consistent surface finish resulting from high-quality abrasives.
- Optimum adaptation to contours due to high flexibility.

Applications:

- Leveling
- Deburring
- Surface work
- Work on edges
- Work on weld seams
- Step-by-step fine grinding

Recommendations for use:

- Use fibre discs conforming to ISO 15636 with backing pads on commercially available angle grinders.

Compatible power tools:

- Angle grinders
- Cordless angle grinders

Ordering notes:

- Please order backing pads separately. More detailed information and ordering data for backing pads can be found on page 22.

Safety notes:

- The maximum approved peripheral speed is 15,800 SFPM.
- For safety reasons, it is imperative to remain within the stated maximum permitted rotational speed at all times.

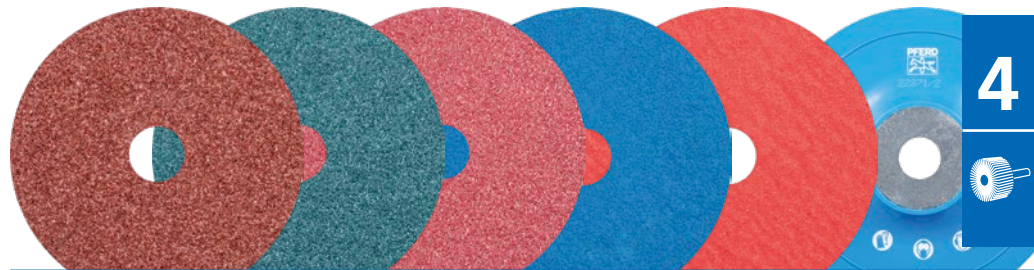

Quick product selection guide

Material group ▼		Abrasive ►	Aluminum oxide A	Zirconia alumina Z	Ceramic oxide CO	Zirconia alumina Z-COOL	Ceramic oxide CO-COOL
Steel, cast steel	Non-hardened, non-heat-treated steels	Construction steels, carbon steels, tool steels, non-alloyed steels, cast steel	●	○	●		
	Hardened, heat-treated steels	Tool steels, tempering steels, alloyed steels, cast steel	○	●	●		
Stainless steel (INOX)	Rust- and acid-resistant steels	Austenitic and ferritic stainless steels		○		●	●
Non-ferrous metals	Soft non-ferrous metals, non-ferrous metals	Soft aluminum alloys	○			○	○
		Brass, copper, zinc	●	○	○		
	Hard non-ferrous metals	Hard aluminum alloys	●	○	○		
		Bronze, titanium		○	○	●	●
	High-temperature-resistant materials	Nickel-based and cobalt-based alloys		○	○	●	●
Cast iron	Grey cast iron, white cast iron	Cast iron with flake graphite, with nodular graphite cast iron, white annealed cast iron, black cast iron	●	○	●		
Plastics, other materials		Fibre-reinforced plastics, thermoplastics, wood, chipboard, paintwork	●				

● = highly recommended

○ = recommended

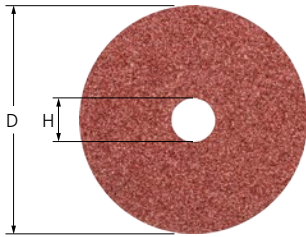

Aluminum oxide A

For universal grinding work from coarse to fine grinding in industry and professional trades.

Abrasive:
Aluminum oxide A

Ordering notes:
■ Please order backing pad separately.
See page 22.

D [Inches]	H [Inches]	Grit and EDP number								Max. RPM	
		16	24	36	50	60	80	100	120		
4-1/2	7/8	62451	62452	62453	62454	62455	62456	62457	62458	13,300	25
5	7/8	62501	62502	62503	62504	62505	62506	62507	62508	12,200	25
7	7/8	62701	62702	62703	62704	62705	62706	-	-	8,500	25

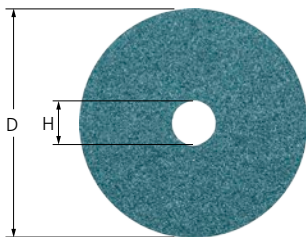

Zirconia alumina Z

For coarse grinding work with a high stock removal rate and a long service life.

Abrasive:
Zirconia alumina Z

Ordering notes:
■ Please order backing pad separately.
See page 22.

Recommendations for use:
■ Use with high-powered angle grinders in the case of a higher contact pressure.

D [Inches]	H [Inches]	Grit and EDP number					Max. RPM	
		24	36	50	60	80		
4-1/2	7/8	62462	62463	62464	62465	62466	13,300	25
5	7/8	62522	62523	62524	62525	62526	12,200	25
7	7/8	62712	62713	62714	62715	62716	8,500	25

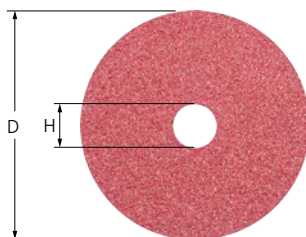

Ceramic oxide CO

For aggressive grinding with a very high stock removal rate and very long service life. Consistently high performance due to self-sharpening ceramic oxide grain.

The ceramic oxide grain is specifically designed for work on hard materials and layers.

Abrasive:
Ceramic oxide CO

Ordering notes:
■ Please order backing pad separately.
See page 22.

Recommendations for use:
■ Use with high-powered angle grinders.

D [Inches]	H [Inches]	Grit and EDP number					Max. RPM	
		24	36	50	60	80		
4-1/2	7/8	62410	62411	62412	62413	62414	13,300	25
5	7/8	62510	62511	-	-	-	12,200	25
7	7/8	62743	62744	62745	-	-	8,500	25



Zirconia alumina Z-COOL

For coarse grinding work with a high stock removal rate and cool grinding.

Active grinding additives in the coating substantially improve the stock removal rate, prevent loading and result in cooler grinding.

Abrasive:

Zirconia alumina Z-COOL

Ordering notes:

■ Please order backing pad separately.
See page 22.

Recommendations for use:

■ Use with high-powered angle grinders in the case of a higher contact pressure.

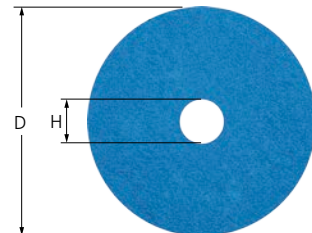

D [Inches]	H [Inches]	Grit and EDP number				Max. RPM	
		36	50	60	80		
4-1/2	7/8	62468	62469	62470	62471	13,300	25
5	7/8	62528	62529	62530	62531	12,200	25
7	7/8	62718	62719	62720	62721	8,500	25

Ceramic oxide CO-COOL

For aggressive grinding with maximum stock removal rate on hard materials which do not conduct heat well. Consistently high performance due to self-sharpening ceramic oxide grain.

Active grinding additives in the coating substantially improve the stock removal rate, prevent loading and result in cooler grinding.

Abrasive:

Ceramic oxide CO-COOL

Ordering notes:

■ Please order backing pad separately.
See page 22.

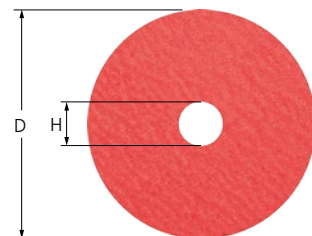

D [Inches]	H [Inches]	Grit and EDP number						Max. RPM	
		24	36	50	60	80	120		
4-1/2	7/8	62416	62417	62418	62419	62420	62421	13,300	25
5	7/8	62516	62517	62518	62519	62520	62521	12,200	25
7	7/8	62749	62750	62751	62752	62753	62754	8,500	25



Fibre discs

Backing pads and accessories



Rubber

High-performance

Temperature-resistant

Backing pads for fibre discs

Backing pads for fibre discs used on commercially available angle grinders.

Rubber backing pads:

Rubber backing pad with a ribbed surface for better cooling to improve disc life. Available in three densities.

High-performance backing pads:

High-performance backing pad with a long service life due to abrasion-resistant, glass-fibre-reinforced plastic. Cool grinding due to radially arranged cooling fins, and high fibre disc stock removal rate due to sturdy, rigid design.

Temperature-resistant backing pads:

Temperature-resistant backing pad with a long service life due to the highly temperature-resistant material. High-precision work with flexible density. Maximum stock removal with hard density.

Ordering notes:

■ The compatible clamping nut is included.

Accessories:

■ Clamping nuts for backing pads

Compatible with these disc dia. [Inches]	Thread size [Inches]	Backing density	EDP number	Compatible clamping nut	Max. RPM	
Rubber backing pads (ribbed surface)						
4-1/2	5/8-11	Regular (R)	69455	69107	13,300	1
5	5/8-11	Regular (R)	69525	69107	12,200	1
7	5/8-11	Flexible (F)	69704	69108	8,500	1
		Regular (R)	69705	69108	8,500	1
		Hard (H)	69706	69108	8,500	1
High-performance backing pads						
4-1/2	5/8-11	Hard (H)	69481	42071	13,300	1
5	5/8-11	Hard (H)	69484	42071	12,200	1
7	5/8-11	Hard (H)	69487	42071	8,500	1
Temperature-resistant backing pads						
4-1/2	5/8-11	Flexible (F)	69480	42071	13,300	1
		Hard (H)	69482	42071	13,300	1
5	5/8-11	Flexible (F)	69483	42071	12,200	1
		Hard (H)	69485	42071	12,200	1
7	5/8-11	Flexible (F)	69486	42071	8,500	1
		Hard (H)	69488	42071	8,500	1



Fibre disc backing pad accessories

Fibre disc backing pad accessories, including clamping nuts and spanner wrench.

Advantages:

■ Matching centre hole distances for standard commercial face pin spanners.

Thread size [Inches]	Compatible with these grinder sizes [Inches]	EDP number	
5/8-11	4-5	69107	1
	7-9	69108	1
	4-1/2-7	42071	1
Spanner wrench	-	69115	1

PSA (pressure-sensitive adhesive) discs are suited to grinding larger surfaces. The flexible system includes a PSA disc and associated holder for use on contours. With the disc holder, PSA discs can be used on commercially available, variable speed or slow-running angle grinders with a 5/16-24 UNC thread.

Advantages:

- Quick disc changes due to flexible system.
- Optimum adaptation to contours because of high flexibility.

Workpiece materials:

- Can be used on nearly all materials.

Applications:

- Leveling
- Deburring
- Surface work
- Work on edges
- Work on weld seams
- Step-by-step fine grinding

Compatible power tools:

- Angle grinders
- Cordless angle grinders

Ordering notes:

- Please order disc holders separately. More detailed information and ordering data for disc holders can be found on page 24.

Safety notes:

- The maximum permitted peripheral speed is 6,300 SFPM.
- For safety reasons, the specified maximum permitted rotational speed must never be exceeded.
- Position the PSA discs centrally on the holder.

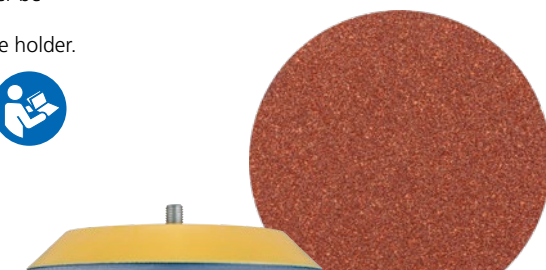

PSA discs

4



Aluminum oxide A

For universal grinding work from coarse to fine grinding in industry and professional trades.

Advantages:

- Recommended for general use on virtually all materials.

Ordering notes:

- Please order disc holder separately.

Abrasive:

Aluminum oxide A



D ₁ [Inches]	Grit and EDP number												Opt. RPM	Max. RPM	
	36	40	50	60	80	100	120	150	180	220	240	320			
5	47361	47362	47363	47364	47365	47366	47367	47368	47369	47370	47371	47372	4,600	4,850	50
6	47374	47375	47376	47377	47378	47379	47380	47381	47382	47383	47384	47385	3,800	4,100	50



PSA discs

PSA discs

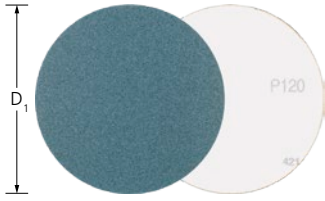

Zirconia alumina Z

Designed for coarse grinding and high stock removal with a long service life.

Advantages:

- Recommended for general use on virtually all materials.

Ordering notes:

- Please order disc holder separately. See below.

Abrasive:

Zirconia alumina Z

D ₁ [Inches]	Grit and EDP number					Opt. RPM	Max. RPM	
	36	40	60	80	120			
5	47560	47561	47563	47564	47566	4,600	4,850	50
6	47570	47571	47573	47574	47576	3,800	4,100	50

PSA disc holders

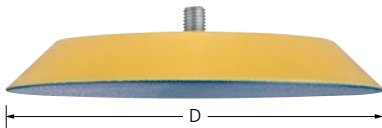

Threaded spindle

Backing pad for use with PSA discs. For threaded spindle (dual action machines).

D [Inches]	Thread	EDP number	Max. RPM	
5	5/16-24	47266	10,000	1
6	5/16-24	47268	10,000	1



Velcro-backed abrasive discs in the NET type feature a netting fabric, to which the abrasive grain is bonded with a high-performance bond system, which makes it very durable.

The range comprises two diameters that have been adapted to the most common power tools, with a comprehensive choice of grain sizes, from 80 to 1,000 grit.

Advantages:

- Very long service life and high stock removal rate.
- Very fine, even surfaces can be achieved.
- Dust-free work due to good extraction capability.
- No loading due to netting structure.
- Durable netting structure with high tear strength and edge stability.

Applications:

- Roughing
- Surface grinding
- Cleaning
- Step-by-step fine grinding

Safety notes:



Compatible power tools:

- Eccentric orbital sanders

Workpiece materials:

- Aluminum
- Additional non-ferrous metals
- Stainless steel (INOX)
- Wood
- Plastics
- Steel, cast steel



Velcro-backed abrasive discs

Aluminum oxide A

For dust-free, universal grinding work on medium-sized and large surfaces.

Abrasive:

Aluminum oxide A

Recommendations for use:

- Use the extraction connection on the machine to effectively remove the grinding dust.

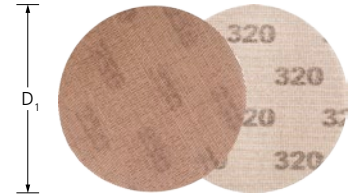

D ₁ [Inches]	Grit and EDP number											
	80	100	120	150	180	240	320	400	600	800	1000	
5	47520	47521	47522	47523	47524	47525	47526	47527	47528	47529	47530	25
6	47531	47532	47533	47534	47535	47536	47537	47538	47539	47540	47541	25



COMBIDISC® quick-change discs

General information

The COMBIDISC® product range contains a wide selection of grinding products for surface finishing. From coarse machining and surface texturing to face-down mirror polishing – the range provides the best product, even for complicated applications.

Advantages:

- Reduced down time due to quick disc changes.
- Great convenience due to simple handling and low-vibration working.
- No operational disruptions caused by sticking, slipping or disengaging.

Applications:

- Roughing
- Leveling
- Deburring
- Surface work
- Work on edges
- Polishing
- Cleaning
- Sharpening
- Work on weld seams
- Structuring surfaces
- Step-by-step fine grinding

Recommendations for use:

- Use COMBIDISC® grinding discs with arbors or abrasive disc holders on flexible shaft drives with angle handpieces, compressed-air or electric angle grinders.

Compatible power tools:

- Flexible shaft drives
- Straight grinders
- Angle grinders
- Cordless angle grinders

Ordering notes:

- Please order arbors or COMBIDISC® abrasive disc holders separately. More detailed information and ordering data can be found on page 37.

Safety notes:

- The maximum permitted peripheral speed is 9,800 SFPM.
- For safety reasons, it is imperative to remain within the stated maximum permitted rotational speed at all times.

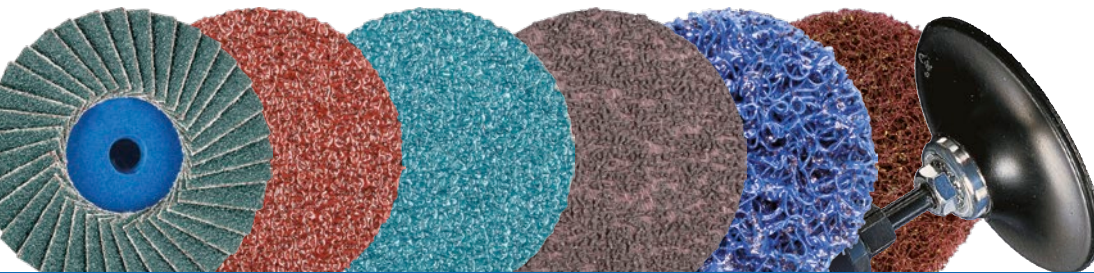

Quick product selection guide

Material group ▼		Abrasive ►	Aluminum oxide A, A-PLUS, A-CONTOUR	Aluminum oxide A compact grain	Zirconia alumina Z
Steel, cast steel	Non-hardened, non-heat-treated steels	Construction steels, carbon steels, tool steels, non-alloyed steels, cast steel	●		○
	Hardened, heat-treated steels	Tool steels, tempering steels, alloyed steels, cast steel	○	●	●
Stainless steel (INOX)	Rust- and acid-resistant steels	Austenitic and ferritic stainless steels		●	○
Non-ferrous metals	Soft non-ferrous metals, non-ferrous metals	Soft aluminum alloys	○		
		Brass, copper, zinc	●		○
	Hard non-ferrous metals	Hard aluminum alloys	●		○
	High-temperature-resistant materials	Nickel-based and cobalt-based alloys			○
Cast iron	Grey cast iron, white cast iron	Cast iron with flake graphite, with nodular graphite cast iron, white annealed cast iron, black cast iron	●		○
Plastics, other materials		Fibre-reinforced plastics, thermoplastics, wood, chipboard, paintwork	●		

● = highly recommended

○ = recommended

PFERD offers two alternative mounting systems:

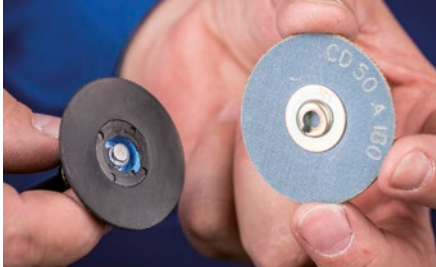

Disc side: Threaded connection with female thread (metal/plastic). Also suitable for the following systems available on the market: PSG, Power Lock Type II "turn on", SocAtt, Turn-On.

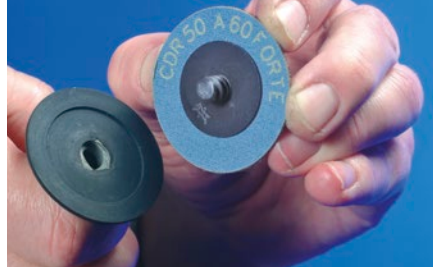

Disc side: Threaded connection with male thread (plastic). Also suitable for the following systems available on the market: Roloc™, Lockit, Speed Lok TR, Power Lock Type III, Fastlock-System B, Roll-On.

PFERDVALUE®:

PFERDERGONOMICS® recommends COMBIDISC® products as a solution to sustainably reduce vibration, noise and dust levels produced by discs and to improve working comfort.

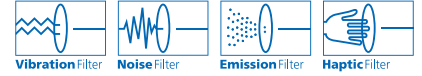

PFERDEFFICIENCY® recommends COMBIDISC® products to reduce disc change and setup times.



Recommended rotational speed range

Example:

EDP: 42292 2" CD CO-COOL

Application:

Grinding alloyed steel

Peripheral speed: 4,000–5,000 SFPM

Rotational speed: 7,600–9,600 RPM

D ₁ [Inches]	Peripheral speed [SFPM]								
	1,000	2,000	3,000	4,000	5,000	6,000	7,000	8,000	10,000
1	3,800	7,600	11,500	15,300	19,100	22,900	26,700	30,600	38,200
1-1/2	2,500	5,100	7,600	10,200	12,700	15,300	17,800	20,400	25,500
2	1,900	3,800	5,700	7,600	9,600	11,500	13,400	15,300	19,100
3	1,300	2,500	3,800	5,100	6,400	7,600	8,900	10,200	12,700

Silicon carbide SiC	Ceramic oxide CO-COOL	Diamond abrasive discs	POLICLEAN® discs	Non-woven discs Soft type, Hard type, Unitized
	●		●	●
	●		○	○
	●		●	●
	○		●	●
			●	●
○			●	●
●	●	●	○	●
	●	●	○	●
			●	●
●		●	●	●

COMBIDISC® quick-change discs

Abrasive discs

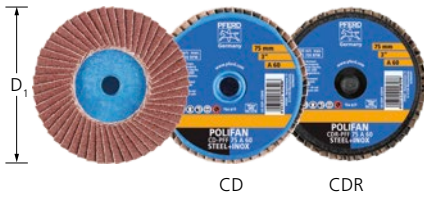

Mini-POLIFAN® Aluminum oxide A

For universal coarse grinding work with high stock removal rates.

Ideal for dressing weld seams in hard-to-reach places.

Longer service life and higher stock removal rate when compared to abrasive discs.

Abrasive:



Aluminum oxide A

Ordering notes:

- Please order arbors or COMBIDISC® abrasive disc holders separately. See below and pg. 37.

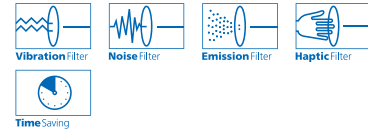
PFERDVALUE®:



D ₁ [Inches]	Grit and EDP number				Opt. RPM	
	40	60	80	120		
CD system 						
2	42802	42803	42804	42805	12,000–14,000	10
3	42808	42809	42810	42811	8,000–10,000	10
CDR system 						
2	42912	42913	42914	42915	12,000–14,000	10
3	42918	42919	42920	42921	8,000–10,000	10

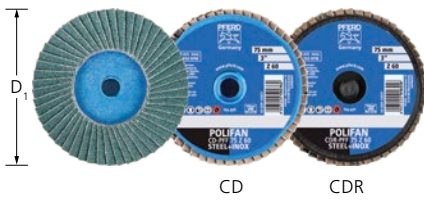

Mini-POLIFAN® Zirconia alumina Z

For coarse grinding work with a high stock removal rate and a long service life.

Abrasive:

Zirconia alumina Z

Recommendations for use:



- Use in the case of a higher contact pressure.

Ordering notes:

- Please order arbors or COMBIDISC® abrasive disc holders separately. See below and pg. 37.

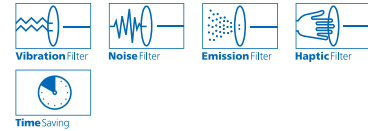
PFERDVALUE®:



D ₁ [Inches]	Grit and EDP number				Opt. RPM	
	40	60	80	120		
CD system 						
2	42814	42815	42816	42817	12,000–14,000	10
3	42820	42821	42822	42823	8,000–10,000	10
CDR system 						
2	42924	42925	42926	42927	12,000–14,000	10
3	42930	42931	42932	42933	8,000–10,000	10

Drive arbors

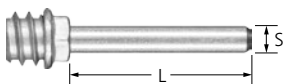

Drive arbors for Mini-POLIFAN® discs

Matching arbor for use with COMBIDISC® Mini-POLIFAN® discs with CD thread.

S [Inches]	L [Inches]	EDP number	Recommended diameters	
1/4	1-1/2	42851	2	1
		42852	3	1

Aluminum oxide A

For universal coarse to fine grinding applications in industry and professional trades.

Abrasive:

Aluminum oxide A

Ordering notes:

- Please order backing pad separately. See page 37.

PFERDVALUE®:

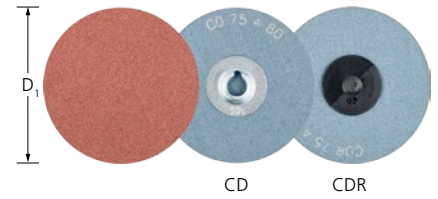
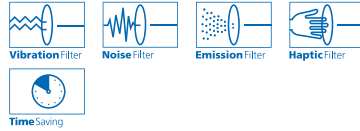

D ₁ [Inches]	Grit and EDP number							Opt. RPM	
	36	50	60	80	120	180	320		
CD system									
1	-	-	42136	42137	42139	42141	42143	15,000–26,000	100
1-1/2	42145	-	42148	42149	42151	42153	42155	10,000–16,000	100
2	42157	42159	42160	42161	42163	42165	42167	8,000–13,000	100
3	42169	42171	42172	42173	42175	42177	42179	5,000–9,000	50
CDR system									
1	-	-	42481	42482	42484	42486	42488	15,000–26,000	100
1-1/2	42490	-	42493	42494	42496	42498	42500	10,000–16,000	100
2	42502	42504	42505	42506	42508	42510	42512	8,000–13,000	100
3	42514	42516	42517	42518	42520	42522	42524	5,000–9,000	50

Aluminum oxide A-PLUS

For universal applications from coarse to fine grinding. Higher stock removal rate due to sturdy backing material. Recommended for use in edge grinding due to high tear strength.

Abrasive:

Aluminum oxide A-PLUS

Ordering notes:

- Please order backing pad separately. See page 37.

PFERDVALUE®:

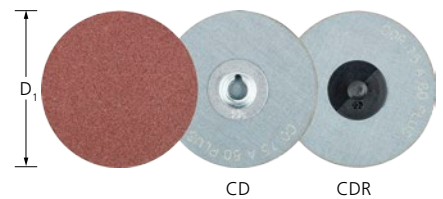
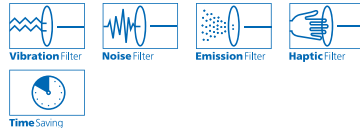

D ₁ [Inches]	Grit and EDP number				Opt. RPM	
	36 PLUS	60 PLUS	80 PLUS	120 PLUS		
CD system						
2	42330	42331	42332	42333	8,000–13,000	100
3	42335	42336	42337	42338	5,000–9,000	50
CDR system						
2	42670	42671	42672	42673	8,000–13,000	100
3	42675	42676	42677	42678	5,000–9,000	50



COMBIDISC® quick-change discs

Abrasive discs

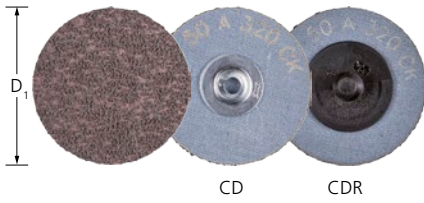

Aluminum oxide A compact grain

Extremely well suited for fine and very fine grinding, and for step-by-step preparations for polishing.



The self-sharpening compact grain facilitates a very long service life and achieves consistent surface quality levels throughout the entire service life.

Abrasive:
Aluminum oxide A compact grain (CK)

Ordering notes:
■ Please order backing pad separately.
See page 37.

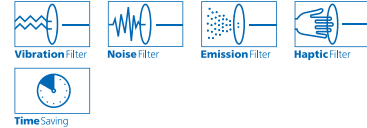
PFERDVALUE®:



	D ₁ [Inches]	Grit and EDP number								Opt. RPM		
		120	180	240	320	400	600	800	1000			1200
CD system												
	2	42936	42937	42938	42939	42940	42941	42942	42943	42944	3,800–13,000	100
	3	42945	42946	42947	42948	42949	42950	42951	42952	42953	2,500–9,000	50
CDR system												
	2	42954	42955	42956	42957	42958	42959	42960	42961	42962	3,800–13,000	100
	3	42963	42964	42965	42966	42967	42968	42969	42970	42971	2,500–9,000	50

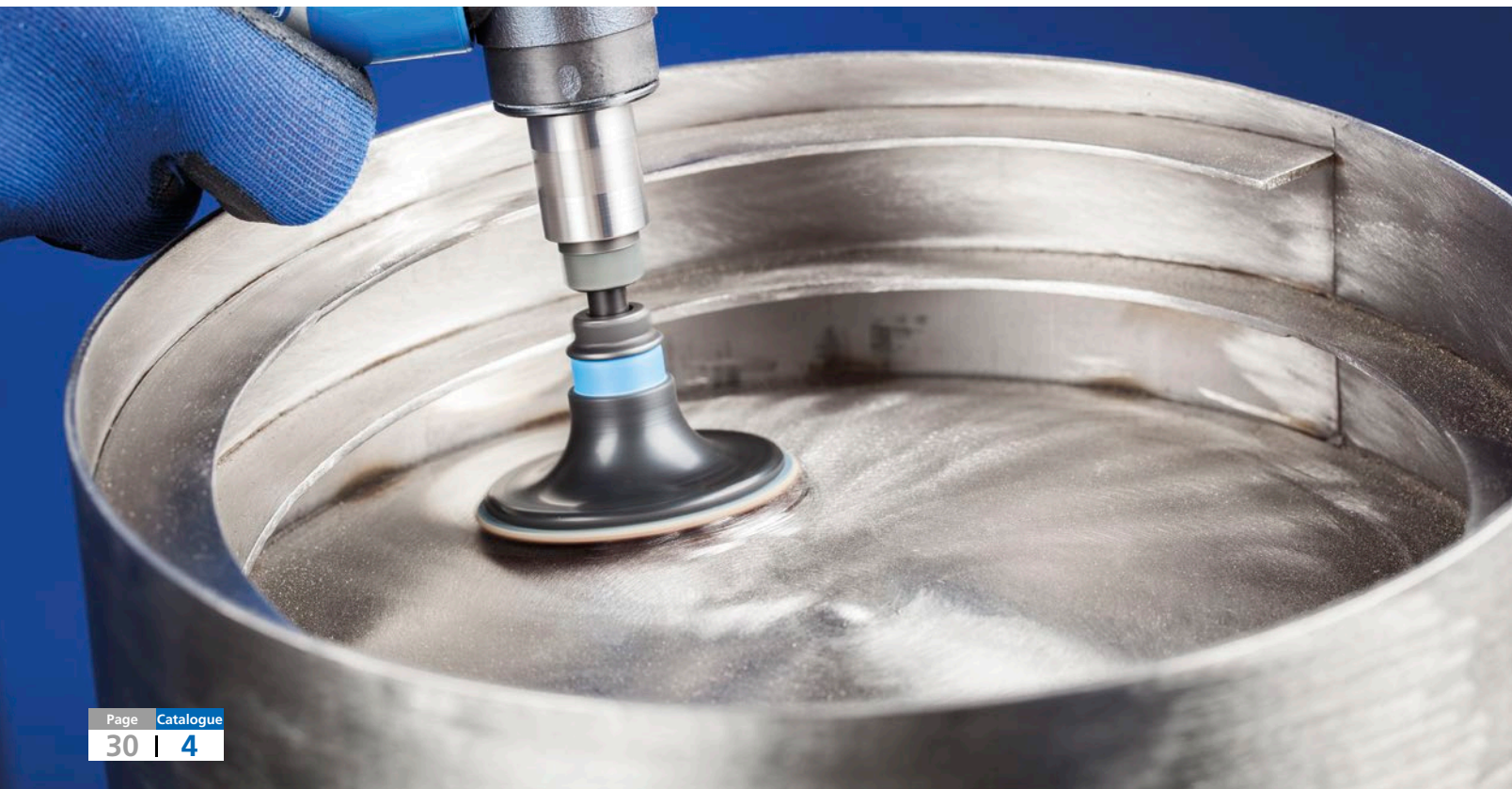

Zirconia alumina Z

For coarse grinding work with a high stock removal rate and a long service life.

Abrasive:

Zirconia alumina Z

Recommendations for use:



- Use with hard or medium-hard COMBIDISC® abrasive disc holders.

Ordering notes:

- Please order backing pad separately. See page 37.

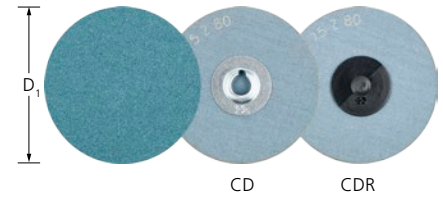
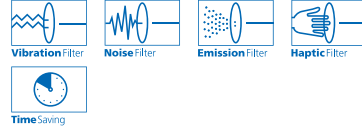
PFERDVALUE®:



	D ₁ [Inches]	Grit and EDP number				Opt. RPM	
		36	50	60	80		
CD system 							
	2	42254	42256	42257	42258	3,800–13,000	100
	3	42261	42263	42264	42265	2,500–9,000	50
CDR system 							
	2	42593	42595	42596	42597	3,800–13,000	100
	3	42600	42602	42603	42604	2,500–9,000	50



COMBIDISC® quick-change discs

Abrasive discs

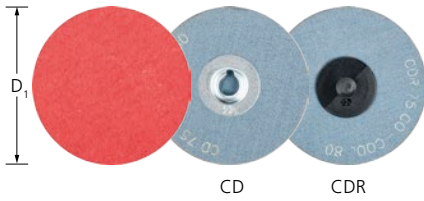

Ceramic oxide CO-COOL

For aggressive grinding with maximum stock removal rate on hard materials which do not conduct heat well. Consistently high performance due to self-sharpening ceramic oxide grain.

Active grinding additives in the coating substantially improve the stock removal rate, prevent loading and result in cooler grinding.

Abrasive:
Ceramic oxide CO-COOL

Ordering notes:
■ Please order backing pad separately.
See page 37.

PFERDVALUE®:

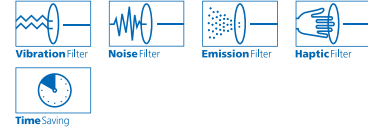

	D ₁ [Inches]	Grit and EDP number					Opt. RPM	
		24	36	60	80	120		
CD system								
	2	42280	42289	42292	42293	42295	3,800–13,000	100
	3	42281	42296	42299	42300	42302	2,500–9,000	50
CDR system								
	2	42619	42628	42631	42632	42634	3,800–13,000	100
	3	42620	42635	42638	42639	42641	2,500–9,000	50

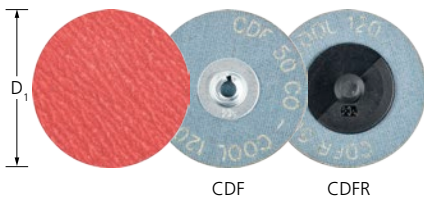

Ceramic oxide CO-COOL mini fibre discs

Exceptionally well-suited to surface and edge grinding. The fibre backing strengthens the abrasive disc and improves stock removal.

For aggressive grinding with maximum stock removal rate on hard materials which do not conduct heat well. Consistently high performance due to self-sharpening ceramic oxide grain.

Active grinding additives in the coating substantially improve the stock removal rate, prevent loading and result in cooler grinding.

Abrasive:
Ceramic oxide CO-COOL

Ordering notes:
■ Please order backing pad separately.
See page 37.

PFERDVALUE®:

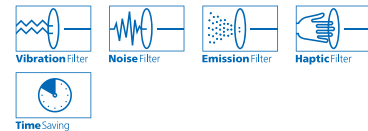

	D ₁ [Inches]	Grit and EDP number				Opt. RPM	
		36	50	80	120		
CDF system							
	2	40492	40494	40496	40497	3,800–13,000	100
	3	40499	40501	40503	40504	2,500–9,000	50
CDFR system							
	2	40632	40634	40636	40637	3,800–13,000	100
	3	40639	40641	40643	40644	2,500–9,000	50

Silicon carbide SiC

For universal grinding work on components made from aluminum, copper, bronze, titanium and fibre-reinforced plastics.

Recommended for use on titanium alloys.

Ideally suited to use in the aeronautical industry, especially where SiC is the only approved abrasive, e.g. for use on engine components.

Abrasive:

Silicon carbide SiC

Ordering notes:

- Please order backing pad separately. See page 37.

PFERDVALUE®:

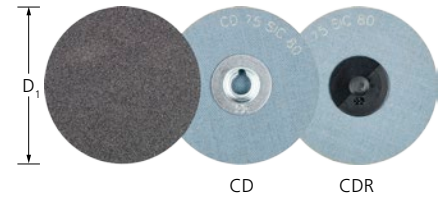
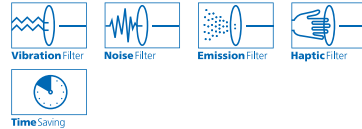

	D ₁ [Inches]	Grit and EDP number					Opt. RPM	
		36	60	80	120	240		
CD system								
	2	42415	42416	42417	42418	42419	3,800–13,000	100
	3	42420	42421	42422	42423	42424	2,500–9,000	50
CDR system								
	2	42750	42751	42752	42753	42754	3,800–13,000	100
	3	42755	42756	42757	42758	42759	2,500–9,000	50

Diamond

Highly recommended for work on wear-resistant coatings and for hard facings made of tungsten carbide, chromium carbide, titanium carbide, etc. Recommended for work on materials used for aircraft engine construction, e.g. HASTELLOY®, INCONEL® and titanium/titanium alloys. Also highly recommended for work on extremely hard materials such as tungsten carbide, glass, ceramics, enamel, stone and carbon-reinforced plastic (CRP)/glass reinforced plastic (GRP).

Abrasive:

Diamond (D)

D 251 = P 60

D 126 = P 120

D 76 = P 220

(P = Grit size according to ISO 6344)

Ordering notes:

- Grit sizes are indicated in µm.
- Please order backing pad separately. See page 37.

PFERDVALUE®:

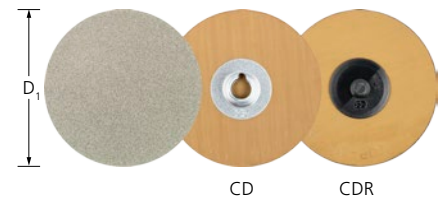
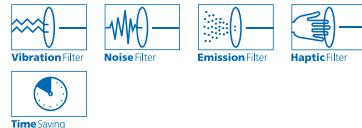

Recommendations for use:

- For the best results, use at a recommended peripheral speed of 2,000–4,000 SFPM.
- Use with hard or medium-hard COMBIDISC® abrasive disc holders.

	D ₁ [Inches]	Grit and EDP number			Opt. RPM	
		D 251 / P 60	D 126 / P 120	D 76 / P 220		
CD system						
	1	40515	40516	40517	7,500–15,000	10
	1-1/2	40518	40519	40520	5,000–10,000	10
	2	40521	40522	40523	3,800–7,500	10
	3	40524	40525	40526	2,500–5,000	10
CDR system						
	1	40655	40656	40657	7,500–15,000	10
	1-1/2	40658	40659	40660	5,000–10,000	10
	2	40661	40662	40663	3,800–7,500	10
	3	40664	40665	40666	2,500–5,000	10

COMBIDISC® quick-change discs

Non-woven discs

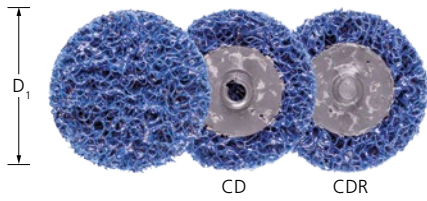

POLICLEAN® PLUS discs

For coarse cleaning work such as removing paint, scale, heat discolouration, rust and adhesive residues in face-down grinding.

POLICLEAN® PLUS discs exhibit a higher stock removal rate with a very long service life.

Applications:
roughing, surface work, cleaning

Abrasive:
Aluminum oxide A



Recommendations for use:
■ Use with hard or medium-hard COMBIDISC® abrasive disc holders.

Ordering notes:

■ Please order backing pad separately.
See page 37.

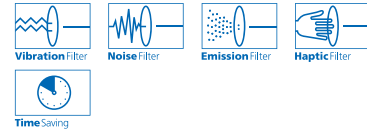
PFERDVALUE®:



	D ₁ [Inches]	EDP number	Opt. RPM	
CD system 				
	2	44840	5,500–8,000	10
	3	44841	3,800–5,000	10
CDR system 				
	2	44842	5,500–8,000	10
	3	44843	3,800–5,000	10



Surface conditioning, hard type

Recommended for universal work on small and medium-sized metal surfaces, e.g. removing rough grinding traces, removing oxidation and light deburring work. Achieve matte and satin-finished surfaces.

Applications:
roughing, deburring, surface work, cleaning, weld dressing, structuring, fine grinding in multiple steps

Abrasive:
Aluminum oxide A
Available POLIVLIES® grit sizes:
100 C = coarse (yellow-brown)
180 M = medium (red-brown)
240 F = fine (blue)



Recommendations for use:
■ The addition of oil or water during grinding results in a finer finish, cooler grinding and longer service life.

Ordering notes:

■ Please order backing pad separately.
See page 37.

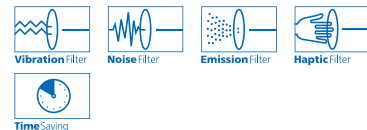
PFERDVALUE®:



	D ₁ [Inches]	Grit, type and EDP number			Opt. RPM	
		100 C	180 M	240 F		
CD system 						
	1-1/2	43176	43177	43179	7,000–10,000	50
	2	43180	43181	43183	5,500–7,500	50
	3	43184	43185	43187	3,800–5,000	25
CDR system 						
	1-1/2	43234	43235	43237	7,000–10,000	50
	2	43238	43239	43241	5,500–7,500	50
	3	43242	43243	43245	3,800–5,000	25
	4	43246	43247	43248	2,850–4,000	25

Finishing, soft type

Recommended for very fine grinding on small and medium-sized surfaces and contours, and for cleaning metal and painted surfaces. Achieve matte and satin-finished surfaces. Highly open structure.

Applications:

roughing, deburring, surface work, cleaning, weld dressing, structuring, fine grinding in multiple steps

Abrasive:

Aluminum oxide A
Available POLINOX® grit sizes:
100 = medium
180 = fine
280 = very fine

Recommendations for use:



■ The addition of oil or water during grinding results in a finer finish, cooler grinding and longer service life.

Ordering notes:

■ Please order backing pad separately.
See page 37.

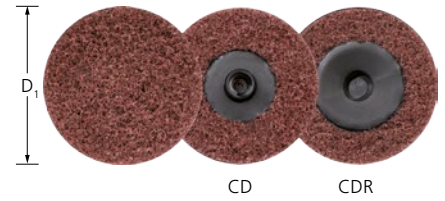
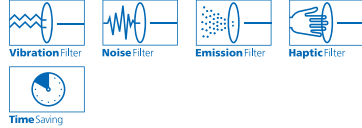
PFERDVALUE®:



D ₁ [Inches]	Grit and EDP number			Opt. RPM	
	100	180	280		
CD system 					
2	43200	43201	43203	5,500–7,500	50
3	43204	43205	43207	3,800–5,000	25
CDR system 					
2	43258	43259	43261	5,500–7,500	50
3	43262	43263	43265	3,800–5,000	25



COMBIDISC® quick-change discs

Non-woven discs



Unitized discs

For achieving a very fine, uniform surface finish which, depending on requirements, is a sufficient preparation for high-gloss polishing. Ideal for work on small and medium-sized surfaces of stainless steel (INOX) components.

The different thicknesses/hardnesses of the non-woven material are colour-coded:

- W (soft) = grey
- MH (medium-hard) = dark blue
- H (hard) = red

Further information on unitized products can be found on pages 85-86.

Applications:

roughing, deburring, surface work, cleaning, weld dressing, structuring, fine grinding in multiple steps

Abrasive:

Aluminum oxide A
Silicon carbide SiC

Ordering notes:

- Please order backing pad separately. See page 37.
- All discs have a thickness of 1/4".

PFERDVALUE®:

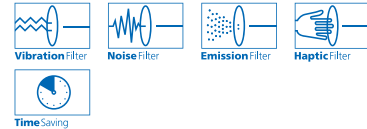

D [Inches]	Abrasives	Grit size	Hardness	Spec	EDP number	Opt. RPM	Max. RPM	
CD system								
2	SiC	fine	W	2SF	48430	9,500	19,100	25
	A	coarse	W	2AM	48431	9,500	19,100	25
	SiC	fine	MH	6SF	48434	9,500	19,100	25
	A	fine	MH	6AF	48435	9,500	19,100	25
	A	fine	H	8AM	48438	9,500	19,100	25
	A	coarse	H	8AC	48439	9,500	19,100	25
3	SiC	fine	W	2SF	48440	6,400	12,500	25
	A	coarse	W	2AM	48441	6,400	12,500	25
	SiC	fine	MH	6SF	48444	6,400	12,500	25
	A	fine	MH	6AF	48445	6,400	12,500	25
	A	fine	H	8AM	48448	6,400	12,500	25
	A	coarse	H	8AC	48449	6,400	12,500	25

CDR system



2	SiC	fine	W	2SF	48450	9,500	19,100	25
	A	coarse	W	2AM	48451	9,500	19,100	25
	SiC	fine	MH	6SF	48454	9,500	19,100	25
	A	fine	MH	6AF	48455	9,500	19,100	25
	A	fine	H	8AM	48458	9,500	19,100	25
	A	coarse	H	8AC	48459	9,500	19,100	25
3	SiC	fine	W	2SF	48460	6,400	12,500	25
	A	coarse	W	2AM	48461	6,400	12,500	25
	SiC	fine	MH	6SF	48464	6,400	12,500	25
	A	fine	MH	6AF	48465	6,400	12,500	25
	A	fine	H	8AM	48468	6,400	12,500	25
	A	coarse	H	8AC	48469	6,400	12,500	25

Felt discs

Recommended for polishing with polishing paste bars, grinding pastes or diamond polishing pastes in face-down grinding on small and medium-sized surfaces.

Applications:
polishing

Recommendations for use:

- For the best results, use at a recommended speed of 1,000–2,000 SFPM. This provides an ideal compromise between polishing performance, thermal load on the workpiece and disc wear.
- When applying a different polishing paste, use a new, unused felt disc.

Ordering notes:

- Further information on felt discs can be found on page 115.
- Please order backing pad and polishing paste separately. See page 37 and 121.

Accessories:

- Grinding and polishing pastes

PFERDVALUE®:

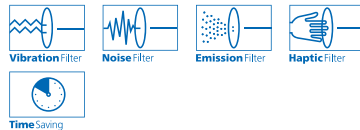

	D ₁ [Inches]	EDP number	Opt. RPM	
CD system				
	2	43215	2,000–4,000	10
	3	43216	1,200–2,500	10
CDR system				
	2	43213	2,000–4,000	10
	3	43214	1,200–2,500	10

Backing pads

Backing pads

Matching backing pads for COMBIDISC® quick-change discs. Available in three different hardness grades.

PFERDVALUE®:



D [Inches]	S [Inches]	EDP number		Max. RPM	
		Type CD 	Type CDR 		
Soft					
1-1/2	1/4	42108	42456	20,000	1
2	1/4	42111	42459	20,000	1
3	1/4	42114	42462	12,000	1
Medium					
1	1/4	42106	42454	40,000	1
1-1/2	1/4	42109	42457	25,000	1
2	1/4	42112	42460	25,000	1
3	1/4	42115	42463	20,000	1
4	1/4	-	42465	10,000	1
Hard					
1-1/2	1/4	42110	42458	30,000	1
2	1/4	42113	42461	30,000	1
3	1/4	42116	42464	20,000	1

COMBIDISC® quick-change discs

Sets



Advantages:

- Getting to know and testing the comprehensive system.

Abrasive:

- Aluminum oxide A
- Silicon carbide SiC

Recommendations for use:

- Use COMBIDISC® grinding discs with an arbor or abrasive disc holder on flexible shaft drives with an angle handpiece or small compressed-air or electric angle grinders.

PFERDVALUE®:

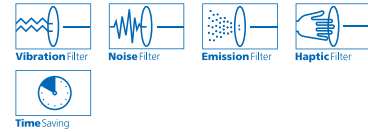

COMBIDISC® prep-to-paint set

Prep-to-paint set includes a selection of coated and non-woven abrasives for removal of surface imperfections such as rust, loose paint or cold drawn mill scale. Selected discs leave the proper surface finish for excellent wet and dry paint and coating adhesion.

Contents of 2" CDR prep-to-paint set

- 1 pc. each of:
- EDP 42460 – 2" CDR backing pad – medium

- EDP 42913 – 2" CDR Mini-POLIFAN® disc A/O 60 grit
 - EDP 44842 – 2" CDR POLICLEAN® PLUS disc
- 4 pcs. of:
- EDP 42506 – 2" CDR abrasive discs A/O 80 grit
 - EDP 43239 – 2" CDR surface conditioning discs medium

Type	Full set EDP number	
Prep-to-paint, 2" CDR attachment	42789	1



COMBIDISC® sanitary finish set

Sanitary finish set includes a selection of coated and non-woven abrasives designed to achieve the industry standard for a sanitary finish.

Contents of 2" CDR sanitary finish set

- 1 pc. each of:
- EDP 42460 – 2" CDR backing pad – medium
 - EDP 42913 – 2" CDR Mini-POLIFAN® disc A/O 60 grit

- 6 pcs. of:
- EDP 42506 – 2" CDR abrasive discs A/O 80 grit
 - EDP 43239 – 2" CDR surface conditioning discs medium

Type	Full set EDP number	
Sanitary finish, 2" CDR attachment	42790	1



COMBIDISC® mirror finish set

Mirror finishing set includes the required components to proceed from raw material removal to a full reflective surface.

Contents of 2" CDR mirror finishing set

- 1 pc. each of:
- EDP 42460 – 2" CDR backing pad – medium
 - EDP 42913 – 2" CDR Mini-POLIFAN® disc A/O 60 grit
 - EDP 43213 – 2" CDR felt disc
 - EDP 48765 – Small bar pre-polishing paste (green)

- 2 pcs. of:
- EDP 48454 – 2" CDR unitized disc medium hard SiC fine
- 3 pcs. of:
- EDP 43239 – 2" CDR surface conditioning discs medium

Type	Full set EDP number	
Mirror finish, 2" CDR attachment	42791	1

PFERD supplies a comprehensive range of products which utilize flexible abrasives.

- Abrasive belts
- Abrasive sheets, cloth and paper-backed
- POLINOX® hand pads for surface conditioning
- Shop rolls and holders
- Abrasive cords

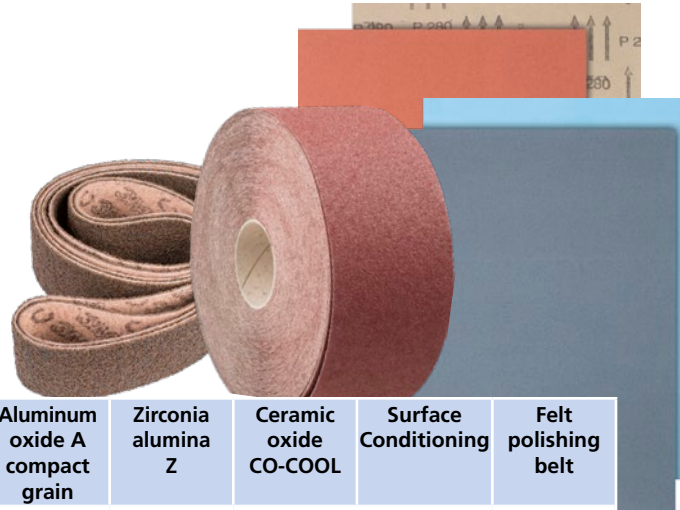

Quick product selection guide

Material group ▼		Abrasive ▶	Recommended peripheral speeds for short and long belts [SFPM]	Aluminum oxide A	Aluminum oxide A compact grain	Zirconia alumina Z	Ceramic oxide CO-COOL	Surface Conditioning	Felt polishing belt
Steel, cast steel	Non-hardened, non-heat-treated steels	Construction steels, carbon steels, tool steels, non-alloyed steels, cast steel	5,000–7,000	●		○		●	●
	Hardened, heat-treated steels	Tool steels, tempering steels, alloyed steels, cast steel	4,000–5,000	○	●	●		○	●
Stainless steel (INOX)	Rust- and acid-resistant steels	Austenitic and ferritic stainless steels	3,000–5,000		●	○	●	●	●
Non-ferrous metals	Soft non-ferrous metals, non-ferrous metals	Soft aluminum alloys	5,000–8,000	○			○	●	●
		Brass, copper, zinc		●		○	●	●	
	Hard non-ferrous metals	Hard aluminum alloys	4,000–5,000	●		○		●	●
		Bronze, titanium				○	●	●	●
	High-temperature-resistant materials	Nickel-based and cobalt-based alloys	1,000–3,000			○	●	●	●
Cast iron	Grey cast iron, white cast iron	Cast iron with flake graphite, with nodular graphite cast iron, white annealed cast iron, black cast iron	5,000–7,000	●		○		●	
Plastics, other materials		Fibre-reinforced plastics, thermoplastics, wood, chipboard, paint-work	2,000–5,000	●				●	●

● = highly recommended ○ = recommended



Abrasive belts, sheets, and rolls

General information – abrasive belts

The comprehensive range of short and long belts is tailored to the belt grinders that are commonly found on the market.

Abrasive belts from PFERD are designated as "abrasive belts" in ISO 2976.

Advantages:

- Increased economic efficiency due to aggressive abrasive performance and long service life.
- High tear strength with optimum flexibility.
- Consistent work results due to high grain adhesion.

Applications:

- Leveling
- Deburring
- Work on edges
- Sharpening
- Work on weld seams
- Step-by-step fine grinding

Recommendations for use:

- Use grinding oil which is recommended for the material to considerably increase service life and abrasive performance of the products.
- Benchstand belts are used for light to moderate duty general purpose grinding on low powered machines. Grinding and finishing is typically against a platen or contact wheel.
- Backstand belts are used for general purpose grinding on heavy-duty machines. Grinding and finishing is performed at a contact wheel for the most aggressive action. Applications include deburring, blending, and finishing.

Compatible power tools:

- Belt grinders

Safety notes:



Recommended rotational speed range

Using the table, you can determine the rotational speed in RPM based on the peripheral speed. Please refer to page 39 for the recommended peripheral speeds.

Example:

EDP: 49008, File belt, aluminum oxide A
 Diameter of the drive roller: 2 inches
 Peripheral speed: 4,000–5,000 SFPM
Rotational speed: 7,400–9,300 RPM

Drive roller dia. [Inches]	Peripheral speed [SFPM]							
	1,000	2,000	3,000	4,000	5,000	6,000	7,000	8,000
	Rotational speeds [RPM]							
3/4	5,000	10,000	15,000	20,100	25,100	30,100	35,100	40,200
1	3,800	7,600	11,400	15,200	19,000	22,900	26,700	30,500
1-1/2	2,500	5,000	7,500	10,000	12,500	15,000	17,500	20,100
2	1,800	3,700	5,600	7,400	9,300	11,200	13,100	14,900
2-1/2	1,500	3,000	4,500	6,000	7,500	9,000	10,600	12,100
3	1,200	2,500	3,700	5,000	6,200	7,500	8,700	10,000
4	900	1,800	2,800	3,700	4,600	5,600	6,500	7,400
5	700	1,500	2,200	3,000	3,700	4,500	5,200	6,000
6	600	1,200	1,800	2,500	3,100	3,700	4,300	5,000
8	400	900	1,400	1,800	2,300	2,800	3,200	3,700
10	350	700	1,100	1,500	1,800	2,200	2,600	3,000
12	300	600	900	1,200	1,500	1,800	2,100	2,500

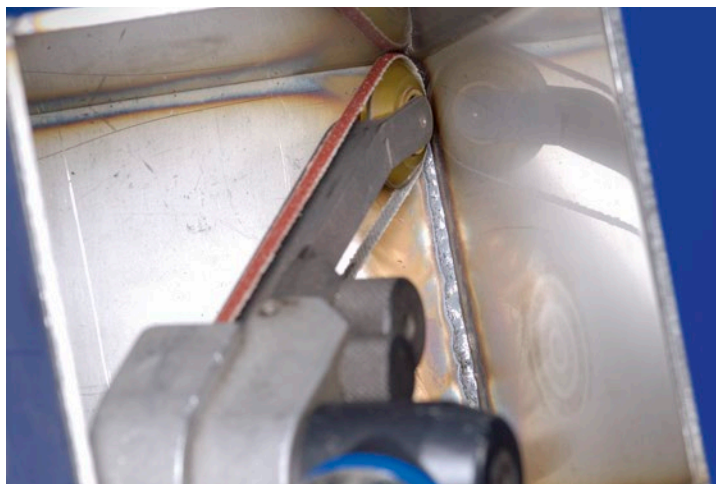



Abrasive belts, sheets, and rolls

Power tool and matching grinding belt dimensions

Manufacturer	Model	Abrasive belts' width x length [Inches]
PFERD	Compressed-air belt grinder	
	90711	1/8 x 12
	95000	1/4 x 12
		3/8 x 12
		1/2 x 12
	Electric belt grinders	
	91410	1/8 x 20-1/2
		1/4 x 20-1/2
		1/2 x 20-1/2
		5/8 x 20-1/2
		3/4 x 20-1/2
		1/4 x 24
	Angle handpieces	
	94385 + 95015	1/8 x 20-1/2
		1/4 x 20-1/2
1/2 x 20-1/2		
5/8 x 20-1/2		
3/4 x 20-1/2		
1/4 x 24		
1/2 x 24		
3M	3M™ file belt sander	1/2 x 18
	Atlas Copco	G2410
ATA	RAL20L	1/2 x 12
Black & Decker	PF260	1/2 x 18
	DS321	3 x 21

Manufacturer	Model	Abrasive belts' width x length [Inches]
DeWalt	DW432	3 x 21
	DW433	
	DWP352VS	
Dynabrade	40352	1/4-3/4 x 18
	40353	
	40320	
	40321	
	40324	
	40335	
	40381	3/4 x 18
	15400	
	40330	
	40615	1/4-3/4 x 18-24
	40503	1/4-3/4 x 24
	15360	
15420		
14000	1/4-1/2 x 12	
15003		
Hitachi	SB10V2	4 x 24
	SB8V2	3 x 21
Genesis	GBS321A	3 x 21
Makita	9910	3 x 18
	9911	3 x 21
	9902	
	9903	
	9920	3 x 24
	9404	4 x 24
	9403	1/4, 1/2 x 21
9032		

Manufacturer	Model	Abrasive belts' width x length [Inches]
Metabo	BF 18 LTX 90	1/4-3/4 x 18
	BFE 9-20	1/4-3/4 x 18
Milwaukee	6101	1/2 x 18
Porter-Cable	352VS	3 x 21
	362V	4 x 24
Rexon	BD480A	4 x 36
	BD460M	
Ryobi	BE319	3 x 18
	P450	3 x 18
	BD461G	4 x 36
SKIL	7510-01	3 x 18
	3376	4 x 36
Suhner	UBC 10-R	1/4-1/2 x 12
	LBC 16 H	
	WB 10	
	LBB 20 DH	1/4-1/2 x 12
Triton	TA 1200BS	3 x 21
WEN	6307	1/2 x 18
	6502	4 x 36
	6321	3 x 21



Abrasive belts, sheets, and rolls

File belts

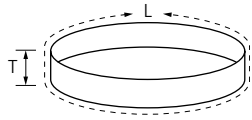

Aluminum oxide A

For universal applications from coarse to fine grinding.

Abrasive:
Aluminum oxide A

L [Inches]	T [Inches]	Grit and EDP number				
		36	60	80	120	
12	1/4	48960	48963	48964	48966	50
	1/2	49024	49027	49028	49030	50
18	1/4	49000	49003	49004	49006	50
	1/2	49032	49035	49036	49038	50
	3/4	49048	49051	49052	49054	50
24	1/4	49008	49011	49012	49014	50
	1/2	49040	49043	49044	49046	50
	3/4	49077	49078	49079	49080	50

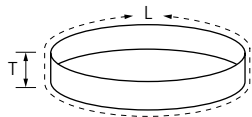

Zirconia alumina Z

For coarse grinding work with a high stock removal rate and a long service life.

Abrasive:
Zirconia alumina Z

L [Inches]	T [Inches]	Grit and EDP number				
		36	60	80	120	
12	1/4	49682	49683	49684	49685	50
	1/2	49712	49715	49716	49727	50
18	1/4	49691	49694	49695	49722	50
	1/2	49717	49720	49730	49731	50
	3/4	49740	49743	49744	49745	50
24	1/4	49696	49699	49700	49706	50
	1/2	49734	49738	49739	49752	50
	3/4	49754	49755	49756	49757	50

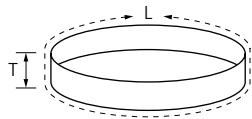
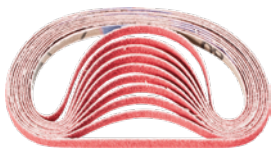

Ceramic oxide CO-COOL

For aggressive grinding with the highest stock removal rates on hard materials which do not conduct heat well. Consistently high performance due to self-sharpening ceramic oxide grain. Active grinding additives in the coating substantially improve the stock removal rate, prevent loading and result in cooler grinding.

Abrasive:
Ceramic oxide CO-COOL

L [Inches]	T [Inches]	Grit and EDP number				
		40	60	80	120	
12	1/4	49492	49493	49494	49495	50
	1/2	49529	49531	49532	49533	50
18	1/4	49497	49499	49500	49501	50
	1/2	49536	49538	49539	49540	50
	3/4	49560	49562	49563	49564	50
24	1/4	49504	49506	49507	49508	50
	1/2	49543	49545	49546	49547	50
	3/4	49723	49724	49725	49726	50

Aluminum oxide A

For universal grinding work from coarse to fine grinding.

Abrasive:
 Aluminum oxide A

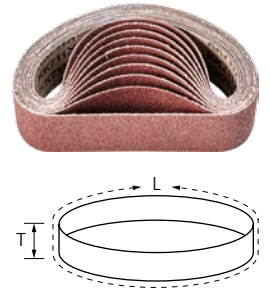

L [Inches]	T [Inches]	Grit and EDP number					
		40	60	80	100	120	
21	3	49211	49213	49214	49215	49216	10
24	3	49250	49252	49253	49254	49255	10
	4	49360	49362	49363	49364	49365	10



Abrasive belts, sheets, and rolls

General information – Belts and accessories for pneumatic drums

The comprehensive range of pneumatic drum belts and accessories offers the best solution for many applications, from aggressive grinding to fine grinding and also for polishing applications.

Advantages:

- Excellent economic efficiency due to high abrasive performance and long service life.
- High tear strength with optimum flexibility.
- The cushioned grinding increases the service life of belts by reducing heat build-up and allowing increased flexibility.

Applications:

- Structuring surfaces
- Polishing
- Step-by-step fine grinding

Recommendations for use:

- For use on linear finishing machine (EDP 91217) see our "Power tools" catalogue section 9.

Compatible power tools:

- Drum grinders

Accessories:

- Pneumatic drum
- Threaded spindle extension

Ordering notes:

- You will find more flap and finishing drums on pages 78, 100–101, and also in catalogue section 8.

Safety notes:

- The maximum permitted peripheral speed is 5,000 SFPM.
- For safety reasons, it is imperative to remain within the stated maximum permitted rotational speed at all times.



Belts and accessories for pneumatic drums

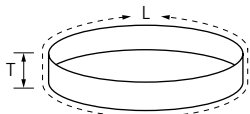

Aluminum oxide A

For universal grinding work from coarse to fine grinding.

Abrasive:

Aluminum oxide A

L [Inches]	T [Inches]	Grit and EDP number					
		40	60	80	100	120	
15-1/2	3-1/2	49312	49314	49315	49316	49317	10

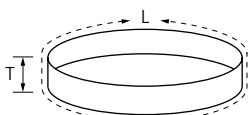

Ceramic oxide CO-COOL

For coarse grinding work with a high stock removal rate and cool grinding.

Active grinding additives in the coating substantially improve the stock removal rate, prevent loading and result in cooler grinding.

Abrasive:

Ceramic oxide CO-COOL

L [Inches]	T [Inches]	Grit and EDP number			
		40	60	80	
15-1/2	3-1/2	49641	49642	49643	10

POLIVLIES® surface conditioning belts

These heavy-duty non-woven surface conditioning belts are manufactured with aluminum oxide impregnated fibre mesh on a tough web backing. The grain is evenly dispersed on the material, resulting in a smooth, uniform finish. The open structure resists loading and can be used wet or dry. The synthetic material will not rust or corrode. Its life can be increased by washing after use. POLIVLIES® belts are designed for buffing, blending, cleaning, light deburring, finishing and polishing on all metals. Particularly well suited for use on stainless and aluminum.

Abrasive:

Aluminum oxide A
 Available POLIVLIES® grit sizes:
 100 C = coarse (yellow-brown)
 180 M = medium (red-brown)
 240 F = fine (blue)

Recommendations for use:

- For the best results, use at a recommended speed of 1,000–3,000 SFPM.

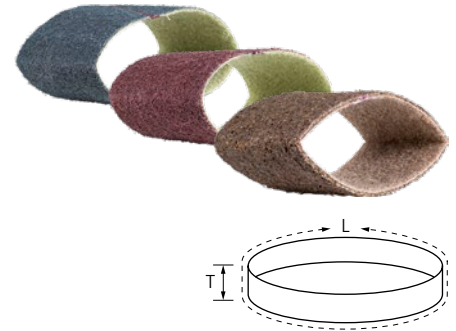

L [Inches]	T [Inches]	Grit, type and EDP number			
		100 C	180 M	240 F	
15-1/2	3-1/2	43613	43614	43615	10

Felt polishing belt

Ideal for use on tubular constructions and rails.

Recommendations for use:

- Apply pre-polishing and high-gloss polishing successively during polishing process.
- When changing the polishing paste, also replace the polishing belt so no contaminants are included from previous step.
- For the best results, use at a recommended speed of 1,000–3,000 SFPM.

Accessories:

- Grinding and polishing pastes

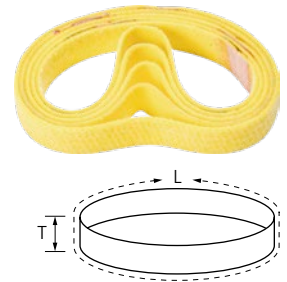

L [Inches]	T [Inches]	EDP number	
15-1/2	3-1/2	43659	5

Pneumatic drum

Pneumatic drum holder for 3-1/2" x 15-1/2" belts. The cushioned grinding increases the service life of belts by reducing heat build-up and allowing more flexibility.



For belt size [Inches]	Drum diameter [Inches]	Max. inflation	Internal thread	EDP number	Max. RPM	
3-1/2 x 15-1/2	5	15 psi	5/8-11	49985	3,800	1

Threaded spindle extension for pneumatic drum

Threaded spindle extension allows pneumatic drum to be mounted on linear finishing tool.



Fits power tool spindle (internal thread)	External thread	EDP number	
5/8-11	5/8-11	49986	1

Abrasive belts, sheets, and rolls

Benchstand belts

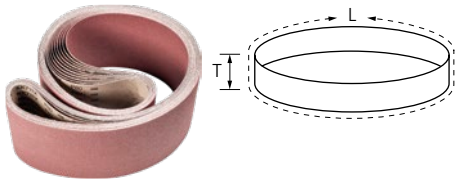

Aluminum oxide A

For universal grinding work from coarse to fine grinding.

Abrasive:
Aluminum oxide A

L [Inches]	T [Inches]	Grit and EDP number					
		36	50	60	80	120	
36	4	-	-	49375	49376	49378	10
42	1	-	49094	49095	49096	49098	10
48	2	49132	49134	49135	49136	49138	10
	6	49464	49466	49467	49468	49470	10
60	2-1/2	49179	49181	49182	49183	-	10

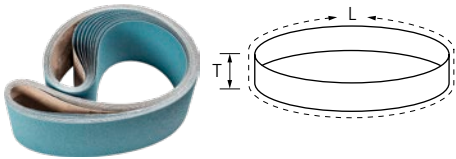

Zirconia alumina Z

For coarse grinding work with a high stock removal rate and a long service life.

Abrasive:
Zirconia alumina Z

L [Inches]	T [Inches]	Grit and EDP number			
		36	60	80	
36	4	49879	49882	49883	10
48	2	49786	49789	49790	10
	6	49885	49888	49889	10
60	2	49792	49795	49796	10
	2-1/2	49828	49831	49832	10

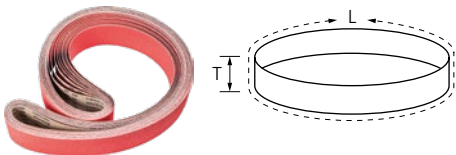

Ceramic oxide CO-COOL

For coarse grinding work with a high stock removal rate and cool grinding. Active grinding additives in the coating substantially improve the stock removal rate, prevent loading and result in cooler grinding.

Abrasive:
Ceramic oxide CO-COOL

L [Inches]	T [Inches]	Grit and EDP number				
		40	60	80	120	
36	4	49658	49660	49661	49662	10
48	2	49588	49590	49591	49592	10
	6	49672	49674	49675	49676	10
60	2	49595	49597	49598	49599	10
	2-1/2	49616	49618	49619	49620	10

Aluminum oxide A

For universal grinding work from coarse to fine grinding.

Abrasive:

Aluminum oxide A

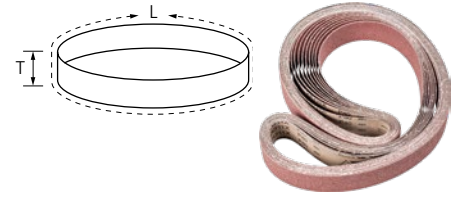

L [Inches]	T [Inches]	Grit and EDP number			
		36	60	80	
132	2	49159	49162	49163	10

Aluminum oxide A compact grain

Extremely well suited to fine and very fine grinding, and for step-by-step preparations for polishing. The self-sharpening compact grain facilitates a very long service life and achieves consistent surface quality levels throughout the entire service life.

Abrasive:

Aluminum oxide A compact grain (CK)

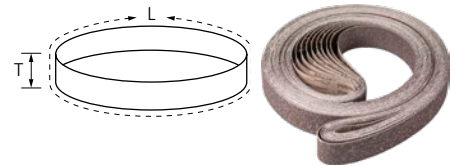

L [Inches]	T [Inches]	Grit and EDP number				
		120	240	400	600	
132	2	49810	49811	49812	49813	10

Ceramic oxide CO-COOL

For coarse grinding work with a high stock removal rate and cool grinding. Active grinding additives in the coating substantially improve the stock removal rate, prevent loading and result in cooler grinding.

Abrasive:

Ceramic oxide CO-COOL

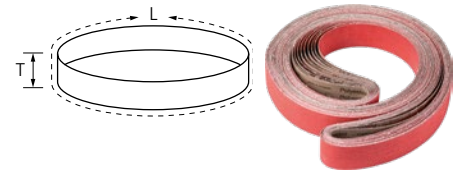

L [Inches]	T [Inches]	Grit and EDP number				
		40	60	80	120	
132	2	49687	49688	49689	49690	10



Abrasive belts, sheets, and rolls

POLIVLIES® surface conditioning belts

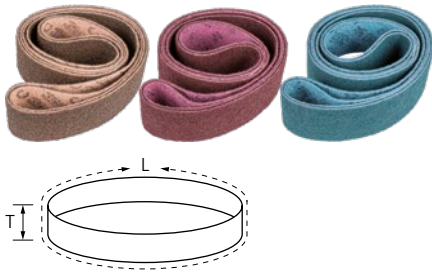

POLIVLIES® surface conditioning belts

Ideal for universal work on metal surfaces in stationary applications, e.g. removal of rough grinding traces, removal of oxidation and light deburring work. Achieve matte and satin-finished surfaces.

Abrasive:

Aluminum oxide A
 Available POLIVLIES® grit sizes:
 100 C = coarse (yellow-brown)
 180 M = medium (red-brown)
 240 F = fine (blue)

Recommendations for use:

■ For the best results, use at a recommended speed of 1,000–3,000 SFPM.

L [Inches]	T [Inches]	Grit, type and EDP number			
		100 C	180 M	240 F	
12	1/4	43634	43635	43636	10
	1/2	43643	43644	43645	10
18	1/4	43550	43551	43552	10
	1/2	43556	43557	43558	10
	3/4	43562	43563	43564	10
24	1/4	43553	43554	43555	10
	1/2	43559	43560	43561	10
	3/4	43666	43667	43668	10
36	4	43660	43661	43662	10
48	2	43672	43673	43674	10
	6	43681	43682	43683	10
60	2	43678	43679	43680	10
	2-1/2	43675	43676	43677	10
132	2	43669	43670	43671	10

Abrasive sheets

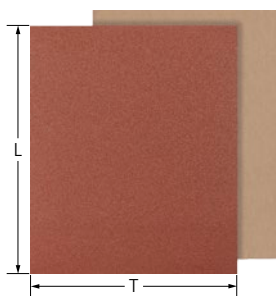

Cloth-backed sheets, heavy-duty

The brown cloth-backed variant is ideal for universal, heavy-duty use on alloyed and non-alloyed steels, as well as non-ferrous metals.

Advantages:

- Very high grain adhesion on very flexible cloth.
- High abrasive performance.
- Oil and kerosene-resistant.

Recommendations for use:

- Tear to the necessary size if required.

Abrasive:

Aluminum oxide A

L [Inches]	T [Inches]	Grit and EDP number							
		40	60	80	100	120	150	180	
11	9	46912	46913	46914	46915	46916	46917	46918	50

L [Inches]	T [Inches]	Grit and EDP number							
		220	240	280	320	400	444		999
11	9	46919	46920	46921	46922	46924	46925	46926	50

Cloth-backed sheets, standard-duty

The blue cloth-backed variant is the low-cost alternative for normal workloads when working on painted wood and metal surfaces.

Advantages:

- Good grain adhesion on sturdy cloth.
- Good abrasive performance.

Abrasive:

Aluminum oxide A

Recommendations for use:

- Tear to the necessary size if required.

Ordering notes:

- Grit sizes 40, 60 and 80 are supplied in packaging units of 50 pieces.

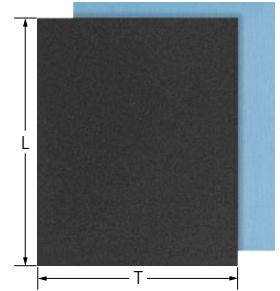

L [Inches]	T [Inches]	Grit and EDP number									
		40	60	80	100	120	150	180	220	240	
11	9	46900	46901	46902	46903	46904	46905	46906	46907	46908	100

Paper-backed sheets, water-resistant

The SiC abrasive enables use on paint and glass. Ideal for all wet grinding work on conventional painted surfaces.

Advantages:

- Very high grain adhesion on very flexible and light paper.
- Maximum abrasive performance.
- Can be used for wet and dry grinding.

Abrasive:

Silicon carbide SiC

Recommendations for use:

- Tear to the necessary size if required.

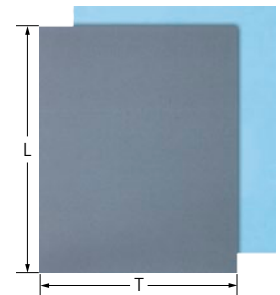

L [Inches]	T [Inches]	Grit and EDP number								
		100	120	150	180	220	240	280	320	
11	9	46927	46928	46929	46930	46931	46932	46933	46934	50

L [Inches]	T [Inches]	Grit and EDP number							
		360	400	500	600	800	1000		1200
11	9	46935	46936	46937	46938	46939	46940	46941	50

Paper-backed sheets, general-purpose

The aluminum oxide A abrasive is the low-cost alternative for normal workloads when working on painted wooden and metal surfaces.

Advantages:

- Good grain adhesion on sturdy paper.
- Good abrasive performance.

Abrasive:

Aluminum oxide A

Ordering notes:

- Grit sizes 40, 60 and 80 are supplied in packaging units of 50 pieces.

Recommendations for use:

- Tear to the necessary size if required.

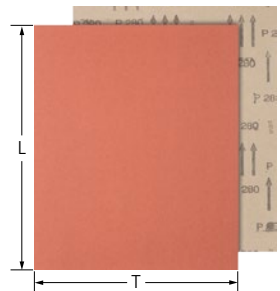

L [Inches]	T [Inches]	Grit and EDP number					
		40	60	80	100	120	
11	9	46942	46943	46944	46945	46946	100

L [Inches]	T [Inches]	Grit and EDP number						
		150	180	220	240		280	400
11	9	46947	46948	46949	46950	46951	46952	100



Abrasive belts, sheets, and rolls

POLINOX® hand pads

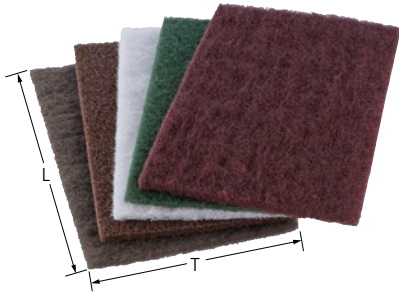

POLINOX® hand pads

Recommended for very fine grinding on small to large surfaces and contours, and for manually cleaning metal and painted surfaces. Achieve matte and satin-finished surfaces. Highly open structure.

Advantages:

- Highly flexible, enabling optimal adjustment to the contour.
- Hard-to-reach areas can be accessed.
- Can be used for wet and dry grinding.

Abrasive:

Aluminum oxide A
Silicon carbide SiC

Recommendations for use:

- Cut to the necessary size if required.

Maroon (general purpose)

Most widely used of all hand pads. Aluminum oxide grain, noted for its toughness and durability on tasks such as cleaning, deburring, rust removal, blending and finishing. May be used dry or with solvents.

Green (food service)

General purpose grade pads made from aluminum oxide. Commonly used in the food service industry, these pads are recommended for light duty and finishing applications.

Tan

This heavy-duty pad consists of a dense aluminum oxide grain concentration on heavy backing material. Designed for the most challenging applications, it is extremely durable and resists tearing and fraying. Excellent for removal of oxidation, weld cleaning, deburring, and finishing stainless steel and aluminum.

White

This hand pad contains no abrasive. It is used primarily for applying lubricants, detergents, polishes, etc. to almost any material. Commonly used for cleaning plastics, glass, ceramics, porcelain, chrome, copper and stainless steel.

Grey

Ultra fine silicon carbide pad provides a precise, fine cutting action. Well suited for light cleaning and fine finishing on a variety of materials including metal, plastic, glass and wood.

Ordering notes:

- Bulk quantities available.

L [Inches]	T [Inches]	EDP number	Description	Grit size	Abrasive	Colour	
9	6	44606	medium finish	100	Aluminum oxide	tan	20
		44600	general purpose	180	Aluminum oxide	maroon	20
		44613	food service	180	Aluminum oxide	green	20
		44609	ultra fine	400	Silicon carbide	grey	20
		44618	non-abrasive	-	None	white	20

Mandrel



Mandrel

Small mandrel designed to grip non-woven material.

Applications:

- Used to reach tight internal diameters.

Recommendations for use:

- Grips a 1 inch wide strip of non-woven material cut to length.

L [Inches]	S [Inches]	EDP number	Max. RPM	
7/8	1/4	44837	14,000	1

Due to their high flexibility, shop rolls are ideal for a range of hand-grinding applications. The matching shop roll holder is ideal for storing and tearing off the belts to the required length.

Advantages:

- Optimum adaptation to contours due to high flexibility.
- Low wear resulting from high tear strength and very high grain adhesion.

Applications:

- Roughing
- Surface work
- Cleaning
- Step-by-step fine grinding

Recommendations for use:

- Cut to the required dimensions if necessary.

Compatible power tools:

- Manual application

Accessories:

- Shop roll holders

Safety notes:



Shop rolls and holders

Heavy-duty shop rolls

Aluminum oxide cloth with a combination resin-over-resin bond most resistant to heat and moisture, very strong bond for best durability. For use on ferrous and non-ferrous metals grinding flat or irregular surfaces, cleaning and polishing of rough ground workpieces.

Abrasive:

Aluminum oxide A

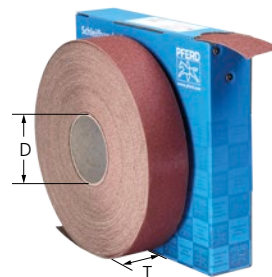

Length [Yards]	T [Inches]	D [Inches]	Grit and EDP number										
			60	80	100	120	150	180	220	240	320	400	
50	1	3	47116	47117	47118	47119	47120	47121	-	47123	47125	47126	1
	1-1/2	3	47166	47167	47168	47169	47170	47171	47172	47173	47175	-	1
	2	3	47216	47217	47218	47219	47220	47221	47222	47223	47225	47226	1

Light, flexible shop rolls

Provides good heat resistance and smooth finishes. Aluminum oxide cloth with resin-over-glue bond, for use on ferrous and non-ferrous metals grinding flat or irregular surfaces, cleaning and polishing of rough ground workpieces.

Abrasive:

Aluminum oxide A

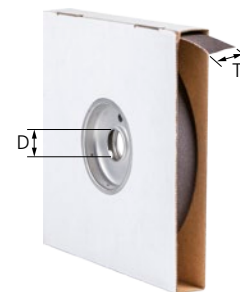

Length [Yards]	T [Inch.]	D [Inch.]	Grit and EDP number												
			50	60	80	100	120	150	180	220	240	320	400	500	
50	1	3	47101	47102	47103	47104	47105	47106	47107	47108	47109	47111	47112	47113	1
	1-1/2	3	47151	47152	47153	47154	47155	47156	47157	47158	47159	47161	47162	47163	1
	2	3	47201	47202	47203	47204	47205	47206	47207	47208	47209	47211	47212	47213	1

Abrasive belts, sheets, and rolls

Shop rolls and holders

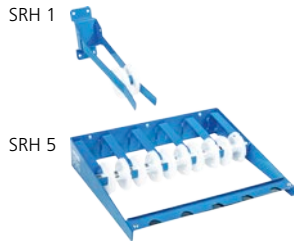

Shop roll holders

Holder for wall-mounting: for storing and tearing off to the required length as necessary. With the multi-roll holder, various roll sizes can be combined with each other as desired.

Type	No. of rolls	Recommended for roll widths [Inches]	Recommended for roll dia. [Inches]	EDP number	
Single roll	1	1, 1-1/2 or 2	15	47238	1
Multi-roll	up to 5	1, 1-1/2 or 2	10	47239	1

Screen rolls



Screen rolls

Silicon carbide screen cloth is highly resistant to loading. Offers long life on ferrous and nonferrous metals, soft metals such as copper and lead, wood, plastics, drywall joint compound and other materials. Double sided.

Abrasive:
Silicon carbide SiC

Length [Yards]	T [Inches]	Grit and EDP number			
		80	120	180	
10	1-1/2	47233	47234	47235	1

Non-woven shop rolls



Aluminum oxide A and silicon carbide SiC

Ideal for very fine grinding on small to large surfaces and contours, and for manually cleaning metal and painted surfaces. Achieve matte and satin-finished surfaces. Highly open structure.

Advantages:

- Highly flexible, enabling optimal adjustment to the contour.
- Hard-to-reach areas can be accessed.
- Can be used for wet and dry grinding.

Recommendations for use:

- Cut to the necessary size if required.

Abrasive:
Aluminum oxide A
Silicon carbide SiC

Length [Yards]	T [Inches]	Abrasives	Grit and EDP number					
			80	100	180	280	400	
10	4	A	43515	43516	43517	43518	-	1
		SiC	-	-	-	-	43519	1

High flexibility abrasive cord

Ideal for very fine deburring and finishing work in hard-to-reach places.

Recommended for work on very small holes, grooves and cut-outs in tool and die making.



Explanation of the abbreviations:

D = Abrasive cord diameter

Abrasive:

Aluminum oxide A
Silicon carbide SiC

D [Inches]	Length [Yards]	Abrasives	Grit and EDP number				
			120	150	180	200	
0.02	16	SiC	-	-	-	49900	1
0.03	16	A	-	-	-	49901	1
0.04	16	A	-	-	49902	-	1
0.06	16	A	-	49903	-	-	1
0.07	16	A	-	-	49904	-	1
0.08	16	A	49905	-	-	-	1



Abrasive spiral bands

General information

The comprehensive range of abrasive spiral bands offers the best solution for every application, from fine grinding to aggressive grinding.

Matching, reusable rubber drum holders in two different shapes are available for using abrasive spiral bands:

- Cylindrical
- Conical

In ISO 2421, abrasive spiral bands are designated as "cylindrical abrasive sleeves".

In ISO 15637-1, cylindrical rubber drum holders are designated as "holding fixtures for cylindrical abrasive sleeves".

Advantages:

- Abrasive spiral bands fit securely on the rubber drum holder as the holder expands during use.
- Outstanding service life due to a special manufacturing process – even under the toughest work conditions.
- Highest possible economic efficiency due to particularly high stock removal and aggressiveness of the abrasive.

Applications:

- Roughing
- Leveling
- Deburring
- Surface work
- Work on edges
- Sharpening
- Work on weld seams
- Step-by-step fine grinding

Recommendations for use:

- To change the abrasive spiral bands, raise and lower them while turning clockwise. When doing so, leave the rubber drum holder engaged in the power tool.
- Adhere to the minimum speed for the rubber drum holder to ensure that the abrasive spiral band fits securely.
- For best performance, use with a recommended peripheral speed of 4,000–6,000 SFPM.
- Use grinding oil recommended for the material in order to increase the service life and abrasive performance of the products.

Compatible power tools:

- Flexible shaft drives
- Straight grinders

Safety notes:

- The maximum permitted peripheral speed is 6,000 SFPM.
- For safety reasons, the specified maximum permitted rotational speed must never be exceeded.
- Do not allow abrasive spiral bands to protrude beyond the rubber drum holder.



Accessories:

- Rubber drum holders



Recommended rotational speed range

Example:

EDP: 41131, 1" spiral band, aluminum oxide A

Peripheral speed: 4,000–6,000 SFPM

Rotational speed: 15,30–22,900 RPM

Band dia. [Inches]	Peripheral speed [SFPM]		
	4,000	5,000	6,000
	Rotational speeds [RPM]		
3/8	40,700	50,900	61,100
1/2	30,600	38,200	45,800
5/8	24,400	30,600	36,700
3/4	20,400	25,500	30,600
7/8	17,500	21,800	26,200
1	15,300	19,100	22,900
1-1/8	13,600	17,000	20,400
1-1/2	10,200	12,700	15,300
1-3/4	8,700	10,900	13,100
2	7,600	9,600	11,500
2-3/8	6,400	8,000	9,700

Quick product selection guide

Material group ▼			Abrasive ▶	Aluminum oxide A	Zirconia alumina Z-COOL	Ceramic oxide CO-COOL
Steel, cast steel	Non-hardened, non-heat-treated steels	Construction steels, carbon steels, tool steels, non-alloyed steels, cast steel	●			●
	Hardened, heat-treated steels	Tool steels, tempering steels, alloyed steels, cast steel	○			●
Stainless steel (INOX)	Rust- and acid-resistant steels	Austenitic and ferritic stainless steels		●		●
Non-ferrous metals	Soft non-ferrous metals, non-ferrous metals	Soft aluminum alloys	○	○		○
		Brass, copper, zinc	●	○		
	Hard non-ferrous metals	Hard aluminum alloys	●	○		
		Bronze, titanium		●		●
	High-temperature-resistant materials	Nickel-based and cobalt-based alloys		●		●
Cast iron	Grey cast iron, white cast iron	Cast iron with flake graphite, with nodular graphite cast iron, white annealed cast iron, black cast iron	●			
Plastics, other materials		Fibre-reinforced plastics, thermoplastics, wood, chipboard, paintwork	●			

● = highly recommended

○ = recommended

4



Abrasive spiral bands

Aluminum oxide A

For universal applications from coarse to fine grinding.

Abrasive:

Aluminum oxide A

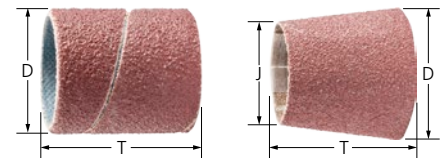

D [Inches]	J [Inches]	T [Inches]	Grit and EDP number					Compatible holder	Opt. RPM		
			40	50	60	80	150				240
Cylindrical type											
3/8	-	3/4	-	-	-	41022	41023	41024	41966	30,000–44,000	100
1/2	-	1	-	-	-	41046	41049	-	41970	30,000–44,000	100
5/8	-	1-1/8	-	41068	41069	41070	41072	41074	41973	26,000–36,000	100
3/4	-	1	-	-	41102	41103	41106	-	41976	20,000–30,000	100
7/8	-	3/4	-	41131	41132	41133	41135	41137	41979	18,000–26,000	100
1	-	1	-	-	41149	41150	41153	-	41982	16,000–22,900	100
1-1/8	-	1-1/8	41190	41191	41192	41193	41195	41197	41985	13,000–19,100	100
1-1/2	-	1	41200	-	41202	41203	41206	-	41988	10,000–15,900	100
1-3/4		1-1/8	41238	41239	41240	41241	41243	41245	41991	8,500–12,700	100
2	-	1	41248	-	41250	41251	41254	-	41994	7,500–11,200	100
2-3/8	-	1-1/8	41295	41296	41297	41298	41300	-	41997	6,500–9,500	100
Tapered type											
3/4	1/2	2-1/2	41350	-	41351	41352	41353	-	42005	19,000–26,000	100
1-1/8	7/8	1-3/16	41355	-	41356	41357	41358	-	42007	13,000–19,100	100
1-1/2	7/8	2-3/8	41360	-	41361	41362	41363	-	42006	10,000–15,900	100

Abrasive spiral bands

Abrasive spiral bands

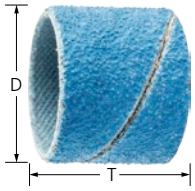

Zirconia alumina Z-COOL type

For coarse grinding work with a high stock removal rate and cool grinding.

Active grinding additives in the coating substantially improve the stock removal rate, prevent loading and results in cooler grinding.

Abrasive:
Zirconia alumina Z-COOL

Ordering notes:

■ Grit size 150 is supplied with aluminum oxide A-COOL (brown).

D [Inches]	T [Inches]	Grit and EDP number				Compatible holder	Opt. RPM	
		36	50	80	150			
Cylindrical shape								
5/8	1-1/8	-	41405	41406	41407	41973	26,000–36,000	100
7/8	3/4	-	41408	41409	41410	41979	18,000–26,000	100
1-1/8	1-1/8	41415	41416	41417	41418	41985	13,000–19,100	100
1-3/4	1-1/8	41419	41420	41421	41422	41991	8,500–12,700	100
2-3/8	1-1/8	41427	41428	41429	41430	41997	6,500–9,500	100

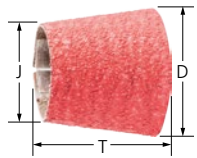

Ceramic oxide CO-COOL

For aggressive grinding with maximum stock removal rate on hard and tough materials which do not conduct heat well. Consistently high performance due to self-sharpening ceramic oxide grain.

Active grinding additives in the coating substantially improve the stock removal rate, prevent loading and results in cooler grinding.

The packaging size is ideally suited to industrial requirements.

Abrasive:
Ceramic oxide CO-COOL

D [Inches]	J [Inches]	T [Inches]	Grit and EDP number				Compatible holder	Opt. RPM	
			36	60	80	120			
Tapered shape									
3/4	1/2	2-1/2	41388	41389	41390	41391	42005	19,000–26,000	100
1-1/8	7/8	1-3/16	41392	41393	41394	41395	42007	13,000–19,100	100
1-1/2	7/8	2-3/8	41396	41397	41398	41399	42006	10,000–15,900	100



Rubber drum holders

Matching rubber drum holder for conical and cylindrical abrasive spiral bands.

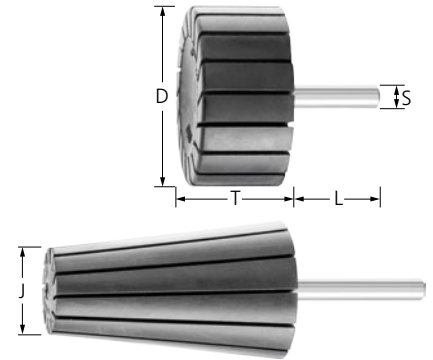

D [Inches]	J [Inches]	T [Inches]	S [Inches]	L [Inches]	EDP number	Max. RPM	
Cylindrical shape							
3/8	-	3/4	1/4	1-5/8	41966	44,000	5
1/2	-	1	1/4	1-5/8	41970	44,000	5
5/8	-	1-1/8	1/4	1-5/8	41973	36,000	5
3/4	-	1	1/4	1-5/8	41976	30,000	5
7/8	-	3/4	1/4	1-5/8	41979	26,000	5
1	-	1	1/4	1-5/8	41982	22,900	5
1-1/8	-	1-1/8	1/4	1-1/4	41985	19,100	5
1-1/2	-	1	1/4	1-1/4	41988	15,900	5
1-3/4	-	1-1/8	1/4	1-1/4	41991	12,700	5
2	-	1	1/4	1-1/4	41994	11,200	5
2-3/8	-	1-1/8	1/4	1-1/4	41997	9,500	5
Tapered shape							
3/4	1/2	2-1/2	1/4	1-5/8	42005	26,000	5
1-1/8	7/8	1-3/16	1/4	1-5/8	42007	19,100	5
1-1/2	7/8	2-3/8	1/4	1-5/8	42006	15,900	5



POLIROLL® cartridge rolls

General information

POLIROLL® cartridge rolls are suited for work in hard-to-reach places.

They consist of spirally wound coated abrasives. The abrasive grain is embedded in the resinoid coating on the sturdy backing material, which achieves the best possible abrasive performance.

Advantages:

- Consistently high abrasive performance throughout the entire service life due to fresh abrasive grain being constantly freed up in operation.
- Secure fit of the POLIROLL® when in use due to self-tensioning provided by grooved, conical arbor.
- Easy cartridge changing.

Applications:

- Leveling
- Deburring
- Work on edges
- Sharpening
- Work on weld seams
- Step-by-step fine grinding

Recommendations for use:

- Grind with the tip instead of the flat surface so as not to damage the bond through exposure to heat.
- Mount POLIROLL® with the bonded side facing towards the arbor.
- Use grinding oil recommended for the material in order to increase the service life and abrasive performance of the products.

Compatible power tools:

- Flexible shaft drives
- Straight grinders

Safety notes:

- The maximum permitted peripheral speed is 2,300 SFPM.
- For safety reasons, the specified maximum permitted rotational speed must never be exceeded.



Accessories:

- Arbors for POLIROLL®



Recommended rotational speed range

Example:

EDP: 41667, 3/4 x 1 cylindrical cartridge roll

Peripheral speed: 1,600 SFPM

Rotational speed: 8,100 RPM

Roll dia. [Inches]	Peripheral speed [SFPM]		
	1,000	1,600	2,200
	Rotational speeds [RPM]		
1/4	15,300	24,400	33,600
5/16	12,000	19,600	26,900
3/8	10,200	16,300	22,400
1/2	7,600	12,200	16,800
5/8	6,100	9,800	13,400
3/4	5,100	8,100	11,200
1	3,800	6,100	8,400



Aluminum oxide A

For universal grinding work on metals and other materials.

Workpiece materials:

aluminum, copper, brass, grey/nodular cast iron, annealed cast iron, steel, cast steel, hardened, heat-treated steels

Abrasive:

Aluminum oxide A

Ordering notes:

Compatible arbor must be ordered separately.

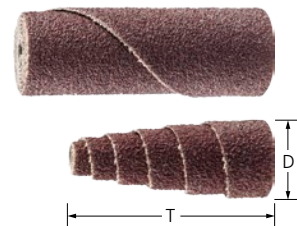

D [Inches]	T [Inches]	Arbor hole [Inches]	Grit and EDP number			Compatible arbor	Opt. RPM	
			60	80	120			
Cylindrical shape								
1/4	1	1/8	41468	41469	41471	42060	20,000	50
	1-1/2	1/8	41479	41480	41482	42061	20,000	50
5/16	1-1/2	1/8	41512	41513	41515	42061	18,500	50
3/8	1	1/8	41523	41524	41526	42060	16,000	50
	1-1/2	1/8	41534	41535	41537	42061	16,000	50
	2	1/8	41545	41546	41548	42062	16,000	50
1/2	1	1/8	41567	41568	41570	42060	12,000	50
	1-1/2	1/8	41589	41590	41592	42061	12,000	50
	2	1/8	41600	41601	41603	42062	12,000	50
5/8	1-1/2	1/8	41633	41634	41636	42061	9,500	50
3/4	1	1/8	41666	41667	41669	42060	8,000	50
	1-1/2	3/16	41677	41678	41680	42063	8,000	50
	2	3/16	41721	41722	41724	42064	8,000	50
1	1-1/2	1/4	41743	41744	41746	42066	6,000	25
	2	1/4	41776	41777	41779	42067	6,000	25
Conical shape								
3/8	1	1/8	41800	41801	41803	42060	16,000	50
	1-1/2	1/8	41807	41808	41810	42061	16,000	50
1/2	1	1/8	41817	41818	41820	42060	12,000	50
	1-1/2	1/8	41827	41828	41830	42061	12,000	50
	2	1/8	41837	41838	41840	42062	12,000	50
3/4	1-1/2	3/16	41874	41875	41876	42063	8,000	50
	2	3/16	41882	41883	41884	42064	8,000	50

Drive arbors

Tapered and untapered cartridge roll holders

Arbors for POLIROLL® cartridge rolls.

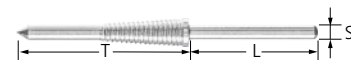

Advantages:

- Roll can be changed without unclamping the arbor from the power tool collet.

S [Inches]	P [Inches]	T [Inches]	L [Inches]	EDP number	Max. RPM	
1/4	1/8	1	1	42060	25,000	1
	1/8	1-1/2	1	42061	25,000	1
	1/8	2	1	42062	24,000	1
	3/16	1-1/2	1	42063	12,000	1
	3/16	2	1	42064	12,000	1
	1/4	1-1/2	1	42066	9,000	1
	1/4	2	1	42067	9,000	1

POLICAP® seamless abrasive caps

General information

The broad, material-specific range of POLICAP® abrasive caps and cones offer solutions with the highest possible stock removal rate for both universal and specialized grinding applications.

POLICAP® products have a seamless design, and the entire surface can be used.

Reusable holders are available when using abrasive caps and cones.

Advantages:

- Abrasive caps and cones fit securely on the holder as it expands during use.
- Consistent shape accuracy and excellent fine grinding due to a special manufacturing process.
- Easy product changing.

Applications:

- Leveling
- Surface work
- Step-by-step fine grinding

Recommendations for use:

- To change the abrasive caps and cones, raise and lower them while turning clockwise. When doing so, leave the abrasive holder engaged in the power tool and fix in place.
- For best performance, use with a recommended peripheral speed of 2,000–4,000 SFPM.

Compatible power tools:

- Flexible shaft drives
- Straight grinders

Safety notes:



- The maximum permitted peripheral speed is 5,000 SFPM.
- For safety reasons, the specified maximum permitted rotational speed must never be exceeded.



Accessories:

- Rubber holders for abrasive caps and cones



Type	Application
Aluminum oxide A  A60/80 A150 A280	For universal use on steel materials (hardened, heat-treated, non-hardened). Especially developed for specific applications, e.g. in tool and die making, in addition to corresponding repair tasks. Also recommended for work on plastics, wood and fillers in model-making applications.
SiC-COOL (Silicon carbide with active grinding layer) 	Ideal for work on components made from titanium, aluminum and their respective alloys. Ideally suited to use in aircraft and turbine construction, in addition to associated maintenance tasks. The special grain selection and the active grinding additive in the bond facilitate cool grinding, reduce the workpiece temperature and prevent chips from adhering.
CO-COOL (Ceramic oxide grain with active grinding layer) 	The specific structure of the ceramic oxide grain and the active-grinding bond components make this ideal for work on stainless steels (INOX) and the high-temperature-resistant nickel-based and cobalt-based alloys that are frequently used in turbine construction, e.g. INCONEL®, HASTELLOY®. The active grinding additives prevent loading and facilitate cooler grinding with considerably higher stock removal rate.

Quick product selection guide

Material group ▼		Abrasive ▶	Aluminum oxide A	Silicon carbide SiC-COOL	Ceramic oxide CO-COOL
Steel, cast steel	Non-hardened, non-heat-treated steels	Construction steels, carbon steels, tool steels, non-alloyed steels, cast steel	●		○
	Hardened, heat-treated steels	Tool steels, tempering steels, alloyed steels, cast steel	○		●
Stainless steel (INOX)	Rust- and acid-resistant steels	Austenitic and ferritic stainless steels			●
Non-ferrous metals	Soft non-ferrous metals, non-ferrous metals	Soft aluminum alloys	○	●	○
		Brass, copper, zinc	●		
	Hard non-ferrous metals	Hard aluminum alloys	○	●	
		Bronze, titanium		●	○
	High-temperature-resistant materials	Nickel-based and cobalt-based alloys			●
Cast iron	Grey cast iron, white cast iron	Cast iron with flake graphite, with nodular graphite cast iron, white annealed cast iron, black cast iron	●		○
Plastics, other materials		Fibre-reinforced plastics, thermoplastics, wood, chipboard, paintwork	○	●	

● = highly recommended

○ = recommended



Recommended rotational speed range

Example:

EDP 46065, cylindrical, shape A, dia. 1/2"

Peripheral speed: 2,000–4,000 SFPM

Rotational speed: 15,300–30,600 RPM

Cap dia. [Inches]	Peripheral speed [SFPM]			
	2,000	3,000	4,000	5,000
	Rotational speeds [RPM]			
3/16	40,700	61,100	81,500	101,900
9/32	27,200	40,700	54,300	67,900
3/8	20,400	30,600	40,700	50,900
1/2	15,300	22,900	30,600	38,200
5/8	12,200	18,300	24,400	30,600
7/8	8,700	13,100	17,500	21,800
1-1/2	5,100	7,600	10,200	12,700



POLICAP® seamless abrasive caps

Abrasive caps, cap holders, and sets



Cylindrical, shape A

POLICAP® abrasive caps in cylindrical shape A.

Abrasive:

Aluminum oxide A
Grit size colour code:
60 and 80 = brown
150 = black
280 = red-brown

D [Inches]	T [Inches]	Grit and EDP number				Compatible holder	Opt. RPM	
		60	80	150	280			
3/16	3/8	-	46029	46030	46031	42008	40,000	50
9/32	1/2	46032	-	46033	46034	42009	30,000	50
3/8	5/8	46035	-	46036	46037	42010	20,000	50
1/2	11/16	46065	-	46066	46067	42021	16,000	50
5/8	1	46068	-	46069	46070	42022	12,000	50

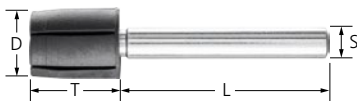

Cylindrical, shape A holders

Matching POLICAP® abrasive cap holder in cylindrical shape A.

D [Inches]	T [Inches]	S [Inches]	L [Inches]	EDP number	Max. RPM	
3/16	3/8	1/8	1-1/4	42008	95,000	5
9/32	1/2	1/8	1-1/4	42009	65,000	5
3/8	5/8	1/8	1-1/4	42010	45,000	5
1/2	11/16	1/4	1-5/8	42021	35,000	5
5/8	1	1/4	1-5/8	42022	30,000	5



Cylindrical, shape A set

110-piece set of various POLICAP® abrasive caps with matching holders in cylindrical shape A.

Contents:

- 105 pieces POLICAP® abrasive caps
- 5 pieces POLICAP® abrasive cap holders
(see table for details)

Advantages:

- Sturdy, reusable plastic packaging.

Abrasive:

Aluminum oxide A
60 and 80 = brown
150 = black
280 = red-brown

Case dimensions [Inches]	D [Inches]	T [Inches]	S [Inches]	Grit and included EDP				POLICAP® qty. included [each]	POLICAP® holder included EDP [1 piece]	Set EDP number	
				60	80	150	280				
7 x 5-3/4 x 1-1/2	3/16	3/8	1/8	-	46029	46030	46031	10	42008	46093	1
	9/32	1/2	1/8	46032	-	46033	46034	10	42009		
	3/8	5/8	1/8	46035	-	46036	46037	5	42010		
	1/2	11/16	1/4	46065	-	46066	46067	5	42021		
	5/8	1	1/4	46068	-	46069	46070	5	42022		

Cylindrical with radius end, shape C

POLICAP® abrasive caps in cylindrical shape C with radius end.

Abrasive:

Aluminum oxide A
Silicon carbide SiC-COOL (grey)
Ceramic oxide CO-COOL (red)

Grit size colour code for aluminum oxide A:

60 and 80 = brown
150 = black
280 = red-brown

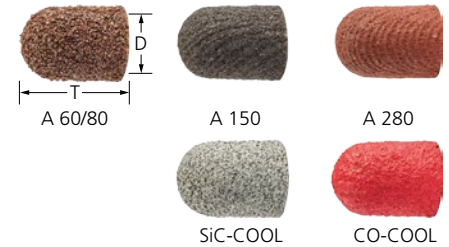

D [Inches]	T [Inches]	Grit and EDP number					Compatible holder	Opt. RPM	
		60	80	120	150	280			
Aluminum oxide A									
3/16	7/16	-	46038	-	46039	46040	42011	40,000	50
9/32	1/2	46041	-	-	46042	46043	42012	30,000	50
3/8	5/8	46044	-	-	46045	46046	42013	20,000	50
1/2	11/16	46071	-	-	46072	46073	42023	16,000	50
5/8	1	46074	-	-	46075	46076	42024	12,000	50
Silicon carbide SiC-COOL									
3/16	7/16	-	46101	-	46102	-	42011	40,000	50
9/32	1/2	-	46104	-	46105	-	42012	30,000	50
3/8	5/8	-	46107	-	46108	-	42013	20,000	50
1/2	11/16	-	46110	-	46111	-	42023	16,000	50
5/8	1	-	46113	-	46114	-	42024	12,000	50
Ceramic oxide CO-COOL									
3/16	7/16	-	46116	46117	-	-	42011	40,000	50
9/32	1/2	-	46119	46120	-	-	42012	30,000	50
3/8	5/8	-	46122	46123	-	-	42013	20,000	50
1/2	11/16	-	46125	46126	-	-	42023	16,000	50
5/8	1	-	46128	46129	-	-	42024	12,000	50

Cylindrical with radius end, shape C holders

Matching POLICAP® abrasive cap holder in cylindrical shape C with radius end.

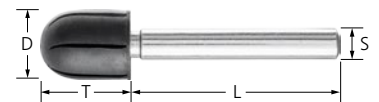

D [Inches]	T [Inches]	S [Inches]	L [Inches]	EDP number	Max. RPM	
3/16	7/16	1/8	1-1/4	42011	95,000	5
9/32	1/2	1/8	1-1/4	42012	65,000	5
3/8	5/8	1/8	1-1/4	42013	45,000	5
1/2	11/16	1/4	1-5/8	42023	35,000	5
5/8	1	1/4	1-5/8	42024	30,000	5

POLICAP® seamless abrasive caps

Abrasive caps, cap holders, and sets



Cylindrical with radius end, shape C set

110-piece set of various POLICAP® abrasive caps with matching holders in cylindrical shape C with radius end.

Contents:

- 105 pieces POLICAP® abrasive caps
- 5 pieces POLICAP® abrasive cap holders (see table for details)

Abrasive:

- Aluminum oxide A
- 60 and 80 = brown
- 150 = black
- 280 = red-brown

Advantages:

- Sturdy, reusable plastic packaging.

Case dimensions [Inches]	D [Inches]	T [Inches]	S [Inches]	Grit and included EDP				POLICAP® qty. included [each]	POLICAP® holder included EDP [1 piece]	Set EDP number	
				60	80	150	280				
7 x 5-3/4 x 1-1/2	3/16	7/16	1/8	-	46038	46039	46040	10	42011	46094	1
	9/32	1/2	1/8	46041	-	46042	46043	10	42012		
	3/8	5/8	1/8	46044	-	46045	46046	5	42013		
	1/2	11/16	1/4	46071	-	46072	46073	5	42023		
	5/8	1	1/4	46074	-	46075	46076	5	42024		

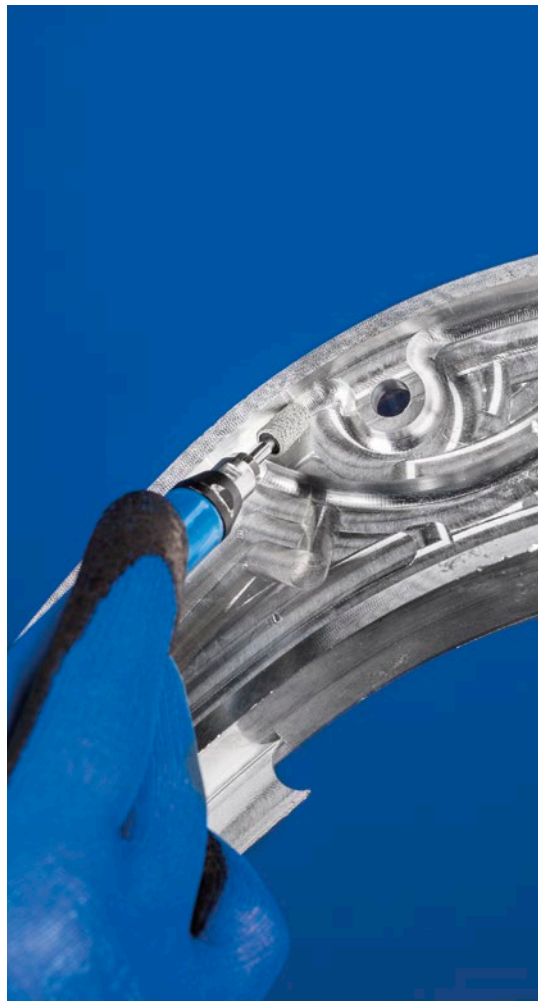

Cylindrical with pointed cone end, shape G

POLICAP® abrasive caps in tapered conical shape G with radius end. The taper angle of the cone is 30°.



Abrasive:

Aluminum oxide A

Grit size colour code:

60 and 80 = brown

150 = black

280 = red-brown

D [Inches]	T [Inches]	Grit and EDP number				Compatible holder	Opt. RPM	
		60	80	150	280			
3/16	7/16	-	46047	46048	46049	42014	40,000	50
9/32	1/2	46050	-	46051	46052	42015	30,000	50
3/8	5/8	46053	-	46054	46055	42016	20,000	50
1/2	11/16	46077	-	46078	46079	42025	16,000	50
5/8	1	46080	-	46081	46082	42026	12,000	50

Cylindrical with pointed cone end, shape G holders

Matching POLICAP® abrasive cap holder in tapered shape G with radius end.



D [Inches]	T [Inches]	S [Inches]	L [Inches]	EDP number	Max. RPM	
3/16	7/16	1/8	1-1/4	42014	95,000	5
9/32	1/2	1/8	1-1/4	42015	65,000	5
3/8	5/8	1/8	1-1/4	42016	45,000	5
1/2	11/16	1/4	1-5/8	42025	35,000	5
5/8	1	1/4	1-5/8	42026	30,000	5

Cylindrical with pointed cone end, shape G set

110-piece set of various POLICAP® abrasive caps with matching holders in tapered conical shape G with radius end.

Contents:

- 105 pieces POLICAP® abrasive caps
- 5 pieces POLICAP® abrasive cap holders (see table for details)

Abrasive:

Aluminum oxide A
 60 and 80 = brown
 150 = black
 280 = red-brown

Advantages:

- Sturdy, reusable plastic packaging.



Case dimensions [Inches]	D [Inches]	T [Inches]	S [Inches]	Grit and included EDP				POLICAP® qty. included [each]	POLICAP® holder included EDP [1 piece]	Set EDP number	
				60	80	150	280				
7 x 5-3/4 x 1-1/2	3/16	7/16	1/8	-	46047	46048	46049	10	42014	46095	1
	9/32	1/2	1/8	46050	-	46051	46052	10	42015		
	3/8	5/8	1/8	46053	-	46054	46055	5	42016		
	1/2	11/16	1/4	46077	-	46078	46079	5	42025		
	5/8	1	1/4	46080	-	46081	46082	5	42026		

POLICAP® seamless abrasive caps

Abrasive caps, cap holders, and sets

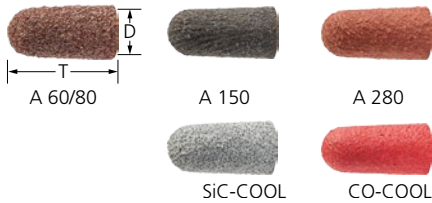

Tapered with radius end, shape L

POLICAP® abrasive caps in conical shape L with radius end.

Abrasive:
 Aluminum oxide A
 Silicon carbide SiC-COOL (grey)
 Ceramic oxide CO-COOL (red)

Grit size colour code for aluminum oxide A:
 60 and 80 = brown
 150 = black
 280 = red-brown

D [Inches]	T [Inches]	Grit and EDP number					Compatible holder	Opt. RPM	
		60	80	120	150	280			
Aluminum oxide A									
1/4	5/8	-	46083	-	46084	46085	42017	40,000	50
7/16	1	46056	-	-	46057	46058	42018	20,000	50
5/8	1-1/4	46059	-	-	46060	46061	42019	12,000	50
27/32	1-9/16	46062	-	-	46063	46064	42020	9,500	50
Silicon carbide SiC-COOL									
1/4	5/8	-	46131	-	46132	-	42017	40,000	50
7/16	1	-	46134	-	46135	-	42018	20,000	50
5/8	1-1/4	-	46137	-	46138	-	42019	12,000	50
27/32	1-9/16	-	46140	-	46141	-	42020	9,500	50
Ceramic oxide CO-COOL									
1/4	5/8	-	46143	46144	-	-	42017	40,000	50
7/16	1	-	46146	46147	-	-	42018	20,000	50
5/8	1-1/4	-	46149	46150	-	-	42019	12,000	50
27/32	1-9/16	-	46152	46153	-	-	42020	9,500	50

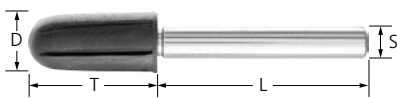

Tapered with radius end, shape L holders

Matching POLICAP® abrasive cap holder in conical shape L with radius end.

D [Inches]	T [Inches]	S [Inches]	L [Inches]	EDP number	Max. RPM	
1/4	5/8	1/4	1-5/8	42017	95,000	5
7/16	1	1/4	1-5/8	42018	40,000	5
5/8	1-1/4	1/4	1-5/8	42019	30,000	5
27/32	1-9/16	1/4	1-5/8	42020	20,000	5

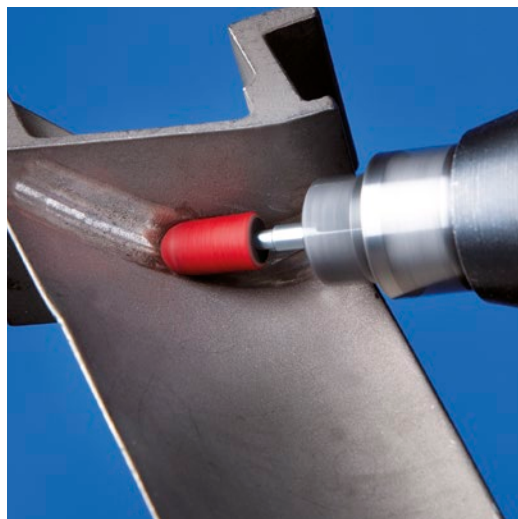

POLICAP® sets

Set of various POLICAP® abrasive caps with matching holders.

Contents PCS 285:

- 270 pieces POLICAP® abrasive caps
- 15 pieces POLICAP® abrasive cap holders
(see table for details)

Contents PCS 650:

- 640 pieces POLICAP® abrasive caps
- 10 pieces POLICAP® abrasive cap holders
(see table for details)

Advantages:

- Sturdy, reusable plastic packaging.

Abrasive:

Aluminum oxide A
 Grit size colour code:
 150 = black
 280 = red-brown



Case dimensions [Inches]	Shape	D [Inches]	T [Inches]	S [Inches]	Grit and included EDP				POLICAP® qty. included [each]	POLICAP® holder included EDP [1 piece]	Set EDP number	
					60	80	150	280				
POLICAP® set PCS 285												
13 x 9-1/4 x 2	A	3/16	3/8	1/8	-	46029	46030	46031	6	42014	46090	1
		9/32	1/2	1/8	46032	-	46033	46034	6	42015		
		3/8	5/8	1/8	46035	-	46036	46037	6	42016		
		1/2	11/16	1/4	46065	-	46066	46067	6	42025		
		5/8	1	1/4	46068	-	46069	46070	6	42026		
	C	3/16	7/16	1/8	-	46038	46039	46040	6	42011		
		9/32	1/2	1/8	46041	-	46042	46043	6	42012		
		3/8	5/8	1/8	46044	-	46045	46046	6	42013		
		1/2	11/16	1/4	46071	-	46072	46073	6	42023		
		5/8	1	1/4	46074	-	46075	46076	6	42024		
	G	3/16	7/16	1/8	-	46047	46048	46049	6	42014		
		9/32	1/2	1/8	46050	-	46051	46052	6	42015		
		3/8	5/8	1/8	46053	-	46054	46055	6	42016		
		1/2	11/16	1/4	46077	-	46078	46079	6	42025		
		5/8	1	1/4	46080	-	46081	46082	6	42026		
POLICAP® set PCS 650												
13 x 9-1/4 x 2	A	3/16	3/8	1/8	-	-	46030	46031	50	42014	46091	1
		9/32	1/2	1/8	-	-	46033	46034	50	42015		
		3/8	5/8	1/8	-	-	46036	46037	25	42016		
		1/2	11/16	1/4	-	-	46066	46067	25	42025		
		5/8	1	1/4	-	-	46069	46070	10	42026		
	G	3/16	7/16	1/8	-	-	46048	46049	50	42014		
		9/32	1/2	1/8	-	-	46051	46052	50	42015		
		3/8	5/8	1/8	-	-	46054	46055	25	42016		
		1/2	11/16	1/4	-	-	46078	46079	25	42025		
		5/8	1	1/4	-	-	46081	46082	10	42026		



POLICAP® abrasive cones and holders

Abrasive cones and holders

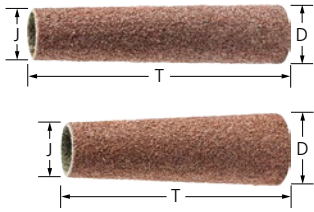

Abrasive cones

POLICAP® abrasive cones with a tapered cylindrical shape.

Abrasive:

Aluminum oxide A
 Grit size colour code:
 60 = brown
 150 = black
 280 = red-brown

D [Inches]	J [Inches]	T [Inches]	Grit and EDP number			Compatible holder	Opt. RPM	
			60	150	280			
5/16	3/16	3-3/8	46008	46009	46010	42001	12,000	10
1/2	7/16	3-3/8	46011	46012	-	42002	12,000	10
3/4	5/8	3-3/8	46014	46015	-	42003	12,000	10
7/8	3/4	3-3/8	46017	46018	-	42004	12,000	10
3/4	1/2	2-1/2	46020	46021	-	42005	18,500	10
1-1/2	7/8	2-3/8	46023	-	-	42006	13,000	10



Rubber abrasive cone holders, shape L

Matching POLICAP® rubber abrasive cone holder in conical shape L with radius end.

Advantages:

- The abrasive spiral bands are firmly held in place on the holder as the rubber surface offers excellent adhesion.

D [Inches]	T [Inches]	S [Inches]	L [Inches]	EDP number	Max. RPM	
5/16	3-3/8	1/4	1-9/16	42001	20,000	5
1/2	3-3/8	1/4	1-9/16	42002	15,000	5
3/4	3-3/8	1/4	1-9/16	42003	13,000	5
7/8	3-3/8	1/4	1-9/16	42004	12,000	5

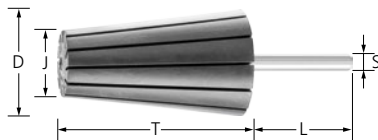

Rubber drum holder

Matching POLICAP® rubber drum holder with a tapered cylindrical shape.

Advantages:

- The abrasive spiral bands are firmly held in place on the holder as the holder expands during use.

D [Inches]	J [Inches]	T [Inches]	S [Inches]	L [Inches]	EDP number	Max. RPM	
3/4	1/2	2-1/2	1/4	1-5/8	42005	26,000	5
1/2	7/8	2-3/8	1/4	1-5/8	42006	15,900	5

On mounted flap wheels, coated abrasive flaps are arranged radially around the wheel axis in a fan-type structure. Their flexibility enables them to adapt perfectly to the contours of the workpiece. The abrasive grain is embedded in the sturdy, flexible cloth backing material by means of a resinoid bond.

In ISO 3919, mounted flap wheels are designated as "flap wheels with shaft".

Factors that influence working results:

■ Flap wheel wear and thermal load:

Flap wheel wear and the thermal load of the workpiece are reduced by decreasing the contact pressure, peripheral speed, and adding grinding oil.

■ Stock removal:

Stock removal rate should be increased by using a coarser granulation and not by increasing the contact pressure. This avoids unnecessary flap wheel wear and prevents the thermal load of the workpiece.

■ Surface roughness:

Increasing the peripheral speed achieves a slightly finer surface. Increasing the contact pressure makes the surface slightly more coarse. The softer the material to be finished, the coarser the surface (when using the same grit sizes).

Advantages:

- Optimum adaptation to contours due to high flexibility.
- Consistently high stock removal throughout the entire service life as new, aggressive abrasive material is constantly exposed.
- Face-down use very close to edges and in corners is possible due to the flat, molded-core design.

Applications:

- Leveling
- Deburring
- Surface work
- Work on weld seams
- Structuring surfaces
- Step-by-step fine grinding

Recommendations for use:

- For best performance, use with a recommended peripheral speed of 3,000–4,000 SFPM. This provides an ideal compromise between stock removal rate, surface quality, thermal load on the workpiece and flap wheel wear.
- Use grinding oil which is recommended for the material in order to considerably increase the service life and abrasive performance of the flap wheels.

Compatible power tools:

- Flexible shaft drives
- Straight grinders

Safety notes:

- For safety reasons, the specified maximum permitted rotational speed must never be exceeded.
- Safety is only guaranteed when:
 - The clamping depth is at least 5/8.
 - The specified maximum rotational speed is not exceeded with unsupported shank lengths.
- The contact pressure has to be reduced significantly when the optimum rotational speed is exceeded.



PFERDVALUE®:

PFERDERGONOMICS® recommends mounted flap wheels to sustainably reduce vibration and noise levels during use and to improve working comfort.



Flap wheels

General information – Mounted flap wheels

Quick product selection guide

Material group ▼		Abrasive ▶	Aluminum oxide A	Zirconia alumina Z-COOL	Ceramic oxide CO-COOL	Silicon carbide SiC-COOL
Steel, cast steel	Non-hardened, non-heat-treated steels	Construction steels, carbon steels, tool steels, non-alloyed steels, cast steel	●	○	○	
	Hardened, heat-treated steels	Tool steels, tempering steels, alloyed steels, cast steel	○	●	●	
Stainless steel (INOX)	Rust- and acid-resistant steels	Austenitic and ferritic stainless steels		●	●	
Non-ferrous metals	Soft non-ferrous metals, non-ferrous metals	Soft aluminum alloys	○			●
		Brass, copper, zinc	●	○	○	
	Hard non-ferrous metals	Hard aluminum alloys	○			●
		Bronze, titanium		○	○	●
High-temperature-resistant materials	Nickel-based and cobalt-based alloys		○	●		
Cast iron	Grey cast iron, white cast iron	Cast iron with flake graphite, with nodular graphite cast iron, white annealed cast iron, black cast iron	●	○	●	
Plastics, other materials		Fibre-reinforced plastics, thermoplastics, wood, chipboard, paintwork	○			●

● = highly recommended

○ = recommended

Recommended rotational speed range

Example:

EDP 45251, Aluminum oxide A, dia. 2"

Peripheral speed: 3,000–4,000 SFPM

Rotational speed: 5,700–7,600 RPM

Wheel dia. [Inches]	Peripheral speed [SFPM]		
	3,000	4,000	7,900
	Rotational speeds [RPM]		
3/8	30,600	40,700	80,500
5/8	18,300	24,400	48,300
3/4	15,300	20,400	40,200
1	11,500	15,300	30,200
1-3/16	9,700	12,900	25,400
1-3/8	8,300	11,100	21,900
1-1/2	7,600	10,200	20,100
2	5,700	7,600	15,100
2-1/2	4,600	6,100	12,100
3	3,800	5,100	10,100

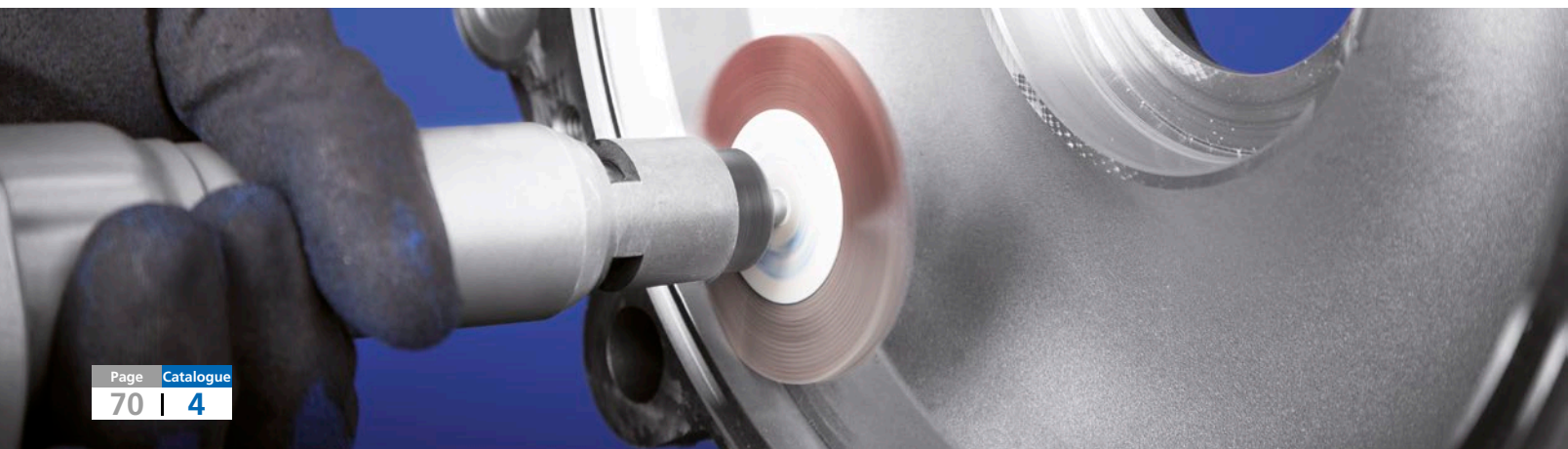



Aluminum oxide A

For universal applications from coarse to fine grinding.

Abrasive:
Aluminum oxide A

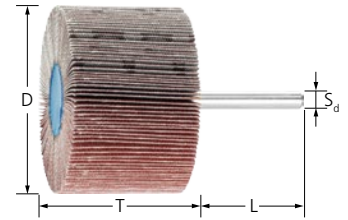
PFERDVALUE®:



D [Inches]	T [Inches]	Grit and EDP number							Opt. RPM	Max. RPM	
		40	60	80	120	180	240	320			
Shank dia. 1/8" x 1-1/2" [S_d x L]											
3/8	3/8	-	45070	45071	45072	45074	45075	-	38,000	75,000	10
	5/8	-	45077	45078	45079	45081	45082	-	38,000	75,000	10
5/8	3/8	-	45091	45092	45093	45095	45096	-	25,000	50,000	10
	5/8	-	45098	45099	45100	45102	45103	-	25,000	50,000	10
3/4	3/8	-	45154	45155	45156	45157	45158	-	19,000	38,100	10
1	1	-	45178	45179	45180	45181	45182	-	15,000	25,400	10
1-3/16	3/8	-	45013	45014	45015	45016	45017	-	12,000	25,400	10
Shank dia. 1/4" x 1-1/2" [S_d x L]											
3/4	3/8	-	45160	45161	45162	-	-	-	19,000	38,100	10
1	5/8	-	45172	45173	45174	45175	-	-	15,000	25,000	10
	1	45463	45184	45185	45186	45187	45188	45189	15,000	25,000	10
1-3/16	1/4	-	45007	45008	45009	-	-	-	12,000	25,000	10
1-3/8	5/8	-	45226	45227	45228	45229	45230	-	10,900	23,000	10
1-1/2	1/2	45244	45245	45246	45247	-	-	-	9,600	23,000	10
	1	-	45232	45233	45234	45235	45236	45237	9,600	23,000	10
2	1/2	-	45251	45252	45253	-	-	-	7,000	23,000	10
	3/4	-	45258	45259	45260	45261	-	-	7,000	23,000	10
2-1/2	1	45461	45238	45239	45240	45241	45242	45243	7,000	23,000	10
	1-1/2	-	45190	45191	45192	-	-	-	7,000	15,000	10
	1/2	45305	45264	45265	45266	-	-	-	6,300	23,000	10
3	1	-	45270	45271	45272	45273	45274	45275	6,300	23,000	10
	1-1/2	45306	45276	45277	45278	-	-	-	6,300	13,000	10
3	1/2	45220	45196	45197	45198	-	-	-	4,800	20,000	10
	1	45462	45208	45209	45210	45211	45212	45213	4,800	20,000	10
	2	-	45214	45215	45216	-	-	-	4,800	6,000	10



Flap wheels

Mounted flap wheels

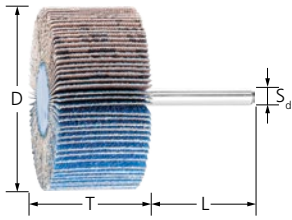

Zirconia alumina Z-COOL

For coarse grinding work with a high stock removal rate and cool grinding.

Active grinding additives in the coating substantially improve the stock removal rate, prevent loading and result in cooler grinding.

Abrasive:
Zirconia alumina Z-COOL

PFERDVALUE®:



D [Inches]	T [Inches]	Grit and EDP number			Opt. RPM	Max. RPM	
		60	80	120			
Shank dia. 1/4" x 1-1/2" [S_d x L]							
1	1	45465	45466	45467	15,000	25,000	10
1-1/2	1	45469	45470	45471	9,600	25,000	10
2	1	45473	45474	45475	7,000	23,000	10
2-1/2	1	45477	45478	45479	7,000	23,000	10
	1-1/2	45488	45489	45490	6,300	13,000	10
3	1/2	45497	45498	45499	4,800	20,000	10
	1	45481	45482	45483	4,800	20,000	10

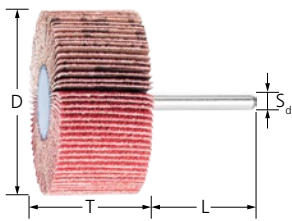

Ceramic oxide CO-COOL

For aggressive grinding with maximum stock removal rate on hard materials which do not conduct heat well. Consistently high performance due to self-sharpening ceramic oxide grain.

Active grinding additives in the coating substantially improve the stock removal rate, prevent loading and result in cooler grinding.

Abrasive:
Ceramic oxide CO-COOL

PFERDVALUE®:



D [Inches]	T [Inches]	Grit and EDP number				Opt. RPM	Max. RPM	
		40	60	80	120			
Shank dia. 1/4" x 1-1/2" [S_d x L]								
1	1	45279	45280	45281	45282	15,000	25,000	10
1-1/2	1	45284	45285	45286	45287	9,600	25,000	10
2	1	45289	45290	45291	45292	7,000	23,000	10
2-1/2	1	45434	45435	45436	45437	7,000	23,000	10
	1-1/2	45443	45444	45445	45446	6,300	13,000	10
3	1/2	45456	45457	45458	45459	4,800	20,000	10
	1	45294	45295	45296	45297	4,800	20,000	10



Silicon carbide SiC

For universal grinding work on components made from aluminum, copper, bronze, titanium and fibre-reinforced plastics.
 Particularly recommended for use on titanium alloys.
 Ideally suited to use in the aeronautical industry, especially where SiC is the only approved abrasive, e.g. for use on engine components.

Abrasive:
 Silicon carbide SiC

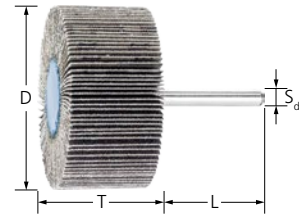
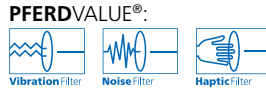

D [Inches]	T [Inches]	Grit and EDP number			Opt. RPM	Max. RPM	
		60	80	120			
Shank dia. 1/4" x 1-1/2" [S_d x L]							
1	1/2	45415	45416	45417	15,000	25,000	10
		45485	45486	45487	15,000	25,000	10
2	1/2	45426	45427	45428	7,000	23,000	10
		45491	45492	45493	7,000	23,000	10
3	1/2	45429	45438	45439	4,800	20,000	10
		45494	45495	45496	4,800	20,000	10

Quick-change flap wheels and accessories

4

Aluminum oxide A

This flap wheel spins on and off without the use of tools. Unique design prevents shaft from pulling out of core while maintaining perfect balance at operating speed. Each package contains 1 shank adaptor with 1/4-20 thread.

Abrasive:
 Aluminum oxide A

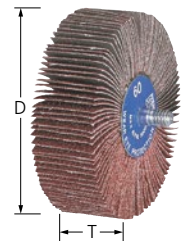
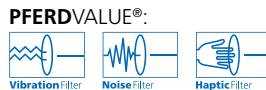

D [Inches]	T [Inches]	Thread	Grit and EDP number						Opt. RPM	Max. RPM	
			40	60	80	120	180	240			
1	5/8	1/4-20	-	45300	45301	45302	-	-	15,000	25,000	10
	1	1/4-20	45316	45310	45311	45312	45313	45314	15,000	25,000	10
1-1/2	1/2	1/4-20	-	45330	45331	45332	-	-	9,600	23,000	10
		1/4-20	45318	45340	45341	45342	-	-	9,600	23,000	10
2	1/2	1/4-20	-	45350	45351	45352	-	-	7,000	23,000	10
		1/4-20	45369	45370	45371	45372	45373	45374	7,000	23,000	10
2-1/2	1/2	1/4-20	-	45410	45411	45412	-	-	6,300	23,000	10
		1/4-20	-	45420	45421	45422	45423	-	6,300	23,000	10
3	1/2	1/4-20	45317	45430	45431	45432	-	-	4,800	20,000	10
		1/4-20	45449	45450	45451	45452	45453	45454	4,800	20,000	10

Threaded shank adapter for quick-change flap wheels

1/4" shank with 1/4-20 female thread.



Shank dia. [Inches]	Thread	EDP number	
1/4	1/4-20	45299	10

Flap wheels

Unmounted flap wheels and accessories

On unmounted flap wheels, coated abrasive flaps are arranged radially around the wheel axis in a fan-type structure. Their flexibility enables them to adapt perfectly to the contours of the workpiece. The abrasive grain is embedded in the sturdy, flexible cloth backing material by means of a resinoid bond.

In ISO 5429, unmounted flap wheels are designated as "flap wheels".

Factors that influence working results:

- **Flap wheel wear and thermal load:**
Flap wheel wear and the thermal load of the workpiece are reduced by decreasing the contact pressure and peripheral speed, and adding grinding oil.
- **Stock removal:**
Stock removal rate should be increased by using a coarser grit and not by increasing the contact pressure. This avoids unnecessary flap wheel wear and prevents the thermal load of the workpiece.
- **Surface roughness:**
Increasing the peripheral speed achieves a slightly finer surface. Increasing the contact pressure makes the surface slightly more coarse. The softer the material to be finished, the coarser the surface (when using the same grit sizes).

Advantages:

- Optimum adaptation to contours due to high flexibility.
- Consistently high stock removal throughout the entire service life as new, aggressive abrasive material is constantly freed up.
- Face-down use very close to edges and in corners is possible due to the special clamping system.

Workpiece materials:

- Can be used on nearly all materials.

Applications:

- Leveling
- Deburring
- Surface work
- Work on weld seams
- Structuring surfaces
- Step-by-step fine grinding

Recommendations for use:

- For best performance, use with a recommended peripheral speed of 3,000–6,000 SFPM. This provides an ideal compromise between stock removal rate, surface quality, thermal load on the workpiece and service life.
- Use grinding oil which is recommended for the material in order to considerably increase the service life and abrasive performance of the flap wheels.
- For best performance, use a power tool with 1,000–1,500 watts.

Ordering notes:

- Unmounted flap wheels with diameters 4, 6 and 6-1/2" are supplied with the centre hole diameter of 1". 8" unmounted flap wheel is supplied with a centre hole diameter of 1-3/4".

Safety notes:

- Unmounted flap wheels are generally to be used with the matching clamping flanges.
- The maximum permitted peripheral speed is defined as follows:
 - Unmounted flap wheels = 9,800 SFPM
 - Unmounted flap wheels for angle grinders = 15,800 SFPM
- Flap drums = 6,300 SFPM
- For safety reasons, the specified maximum permitted rotational speed must never be exceeded.
- The contact pressure has to be reduced significantly when the optimum rotational speed is exceeded.



Accessories:

- Arbors with clamping flange
- Reducing flanges for unmounted flap wheels

PFERDVALUE®:

PFERDERGONOMICS® recommends unmounted flap wheels to sustainably reduce vibration and noise levels during use and to improve working comfort.



Recommended rotational speed range

Example:

EDP 45620, Aluminum oxide A, dia. 6"
Peripheral speed: 3,000–6,000 SFPM
Rotational speed: 1,900–3,800 RPM

Wheel dia. [Inches]	Peripheral speed [SFPM]						
	3,000	4,000	5,000	6,000	7,900	9,900	15,800
	Rotational speeds [RPM]						
4	2,900	3,800	4,800	5,700	7,500	9,500	15,100
4-1/2	2,500	3,400	4,200	5,100	6,700	8,400	13,400
5	2,300	3,100	3,800	4,600	6,000	7,600	12,100
6	1,900	2,500	3,200	3,800	5,000	6,300	10,100
7	1,600	2,200	2,700	3,300	4,300	5,400	8,600
8	1,400	1,900	2,400	2,900	3,800	4,700	7,500

Aluminum oxide A

For universal applications from coarse to fine grinding.

Abrasive:

Aluminum oxide A

Compatible power tools:

flexible shaft drive, straight grinder

PFERDVALUE®:

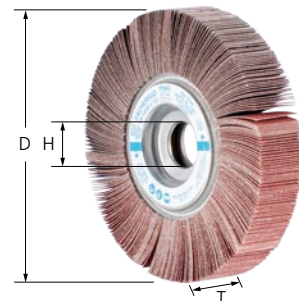

Ordering notes:

- Please order the matching arbor separately.
- Matching arbor for a diameter of 4–6": EDP 45714
- Matching arbor for a diameter of 8–10": EDP 45715

D [Inches]	T [Inches]	H [Inches]	Grit and EDP number						Opt. RPM	Max. RPM	
			40	60	80	120	180	240			
4	1	1	45530	45532	45533	45535	45536	-	5,500	9,500	2
	2	1	-	45552	45553	45555	-	-	5,500	9,500	2
6	1	1	45600	45602	45603	45605	45607	-	3,500	6,300	2
	1-1/2	1	45610	45612	45613	-	-	-	3,500	6,300	2
8	2	1	45620	45622	45623	45625	45626	45627	3,500	6,300	2
	1	1-3/4	-	45642	45643	45645	-	-	2,600	4,700	2
	2	1-3/4	-	45652	45653	45655	-	-	2,600	4,700	2

Ceramic oxide CO-COOL

For aggressive grinding with maximum stock removal rate on hard materials which do not conduct heat well. Consistently high performance due to self-sharpening ceramic oxide grain.

Active grinding additives in the coating substantially improve the stock removal rate, prevent loading and result in cooler grinding.

Abrasive:

Ceramic oxide CO-COOL

Compatible power tools:

flexible shaft drive, straight grinder

Ordering notes:

- Please order the matching arbor separately.
- Matching arbor for a diameter of 6": EDP 45714

PFERDVALUE®:

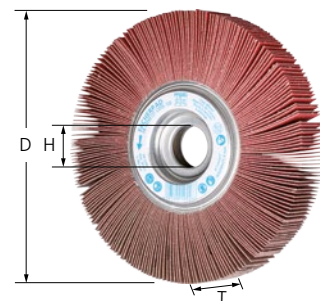

D [Inches]	T [Inches]	H [Inches]	Grit and EDP number				Opt. RPM	Max. RPM	
			40	60	80	120			
6	1	1	45840	45841	45842	45843	3,500	6,300	2
	2	1	45844	45845	45846	45847	3,500	6,300	2

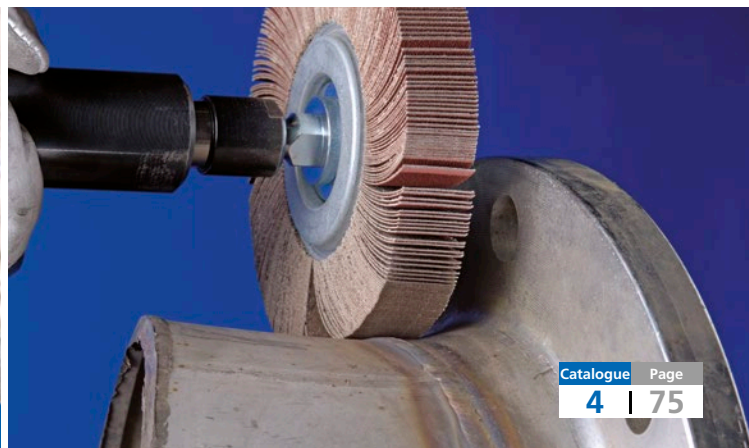

Flap wheels

Unmounted flap wheels and accessories

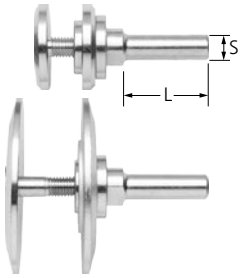

Clamping flanges for unmounted flap wheels

For mounting PFERD unmounted flap wheels.
The clamping flanges are designed to lie countersunk in the wheel.

Advantages:

- Can be used face-down very close to edges and in angles due to special clamping system.

Ordering notes:

- Included in delivery: Arbor, clamping diameter of 1/2", 2 flanges and matching screws (for different unmounted flap wheel widths).
- Contents include one arbor (1/2" clamping dia.), two flanges, compatible clamping screws (for various flap wheel widths)

S [Inches]	L [Inches]	Fits arbor hole size [Inches]	For wheel diameter [Inches]	EDP number	
1/2	1-1/2	1	4-6	45714	1
1/2	1-1/2	1-3/4	8-10	45715	1

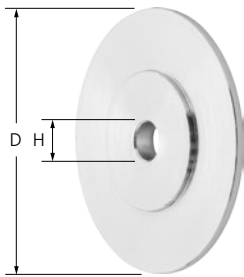

Reducing flanges for unmounted flap wheels

For mounting unmounted flap wheels and POLINOX® unmounted flap wheels on drive spindles.
The clamping flanges are designed to lie countersunk in the wheel.

Advantages:

- Can be adapted to an existing drive spindle by drilling.
- Can be used face-down very close to edges and in angles due to unique clamping system.

Ordering notes:

- Included in delivery: 1 pair

Fits arbor hole size [Inches]	D [Inches]	H [Inches]	Max. H [Inches]	For wheel diameter [Inches]	EDP number	
1	1-1/2	1/2	7/8	4-6	45720	1
	1-1/2	5/8	7/8	4-6	45721	1
	1-1/2	3/4	7/8	4-6	45722	1
1-3/4	3-1/4	1/2	1-1/2	8-10	45725	1
	3-1/4	5/8	1-1/2	8-10	45726	1
	3-1/4	3/4	1-1/2	8-10	45727	1
	3-1/4	1	1-1/2	8-10	45728	1

Aluminum oxide A

The ideal flap wheel for use on angle grinders in assembly shop operations. For universal applications from coarse to fine grinding.

Advantages:

- Can be mounted directly on the angle grinder without additional clamping devices.

Abrasive:

Aluminum oxide A

Recommendations for use:

- For the best results, use at a recommended peripheral speed of 7,900–9,800 SFPM.

Compatible power tools:

angle grinder, cordless angle grinder

Safety notes:

- As a rule, unmounted flap wheels should be used with the appropriate clamping flanges for the angle grinder.

PFERDVALUE®:



D [Inches]	T [Inches]	Thread	Grit and EDP number							Opt. RPM	Max. RPM	
			40	60	80	120	180	240	320			
4-1/2	3/4	5/8-11	45751	45753	45754	45755	45757	45758	45759	7,500	13,300	2
5	3/4	5/8-11	45761	45763	45764	45765	45767	45768	45769	6,850	12,200	2

Ceramic oxide CO-COOL

The ideal flap wheel for use on angle grinders in assembly shop operations. For aggressive grinding with maximum stock removal rate on hard materials which do not conduct heat well. Consistently high performance due to self-sharpening ceramic oxide grain.

Active grinding additives in the coating substantially improve the stock removal rate, prevent loading and result in cooler grinding.

Advantages:

- Can be mounted directly on the angle grinder without additional clamping devices.

Abrasive:

Ceramic oxide CO-COOL

Recommendations for use:

- For the best results, use at a recommended peripheral speed of 7,900–9,800 SFPM.

Compatible power tools:

angle grinder, cordless angle grinder

Safety notes:

- As a rule, unmounted flap wheels should be used with the appropriate clamping flanges for the angle grinder.

PFERDVALUE®:

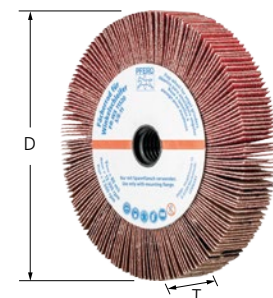

D [Inches]	T [Inches]	Thread	Grit and EDP number				Opt. RPM	Max. RPM	
			40	60	80	120			
4-1/2	5/8	5/8-11	45740	45741	45742	45743	7,500	13,300	2
5	5/8	5/8-11	45744	45745	45746	45747	6,850	12,200	2



Flap wheels

Flap drums

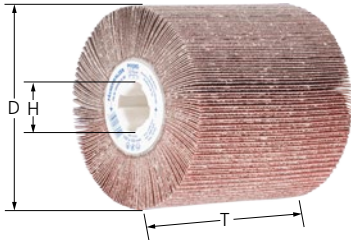

Aluminum oxide A

For universal work on medium-sized and large metallic surfaces, e.g. fine grinding work on large radii in container, food service and apparatus construction, and achieving consistent linear scratch patterns on large surfaces and contours in manual applications.

Ideal for all conventional keyway systems.

Abrasive:

Aluminum oxide A

Recommendations for use:

- For the best results, use at a recommended peripheral speed of 3,000-6,000 SFPM.

Compatible power tools:

drum grinders

Ordering notes:

- Additional drum products can be found on pages 44, 45, 100, 101 and 120, as well as in catalogue section 8.
- Refer to our "Power tools" catalogue section 9 for information on the linear finishing tool, EDP 91217.

PFERDVALUE®:



D [Inches]	T [Inches]	H [Inches]	Grit and EDP number					Opt. RPM	Max. RPM		
			40	60	80	120	150				180
4	4	3/4	45780	45781	45782	45783	45784	45785	3,800	6,100	1



The POLIFLAP® system is ideal for blending and restoring surface textures, fine grinding of radii, contours, curved areas or large surfaces.

Safety notes:

- The maximum permitted peripheral speed is 6,300 SFPM.
- For safety reasons, the specified maximum permitted rotational speed must never be exceeded.



Accessories:

- POLIFLAP® abrasive flaps
- POLIFLAP® rubber flaps

PFERDVALUE®:

PFERDERGONOMICS® recommends the POLIFLAP® system to sustainably reduce vibration and noise levels during use and to improve working comfort.

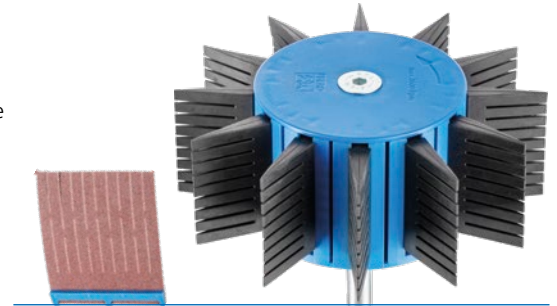

POLIFLAP® system

POLIFLAP® wheel

The wheel consists of a shank-mounted support and rubber flaps. It must be completed with appropriate abrasive flaps. The customized arrangement of abrasive and rubber flaps results in a highly versatile product.

Advantages:

- Optimal harmonization of different surface structures.
- Creates a consistently high surface quality over the entire service life as new, sharp abrasive is constantly exposed.
- Comfortable to use due to particularly lightweight design.

Recommendations for use:

- For optimum results on stainless steel (INOX), use at a rotational speed between 1,400–1,700 RPM.
- In the event of excessive wear, we recommend replacing the flaps frequently.

Compatible power tools:

flexible shaft drive, straight grinder

Ordering notes:

- Supplied without abrasive flaps. Please order abrasive flaps separately in the desired grit size.

PFERDVALUE®:

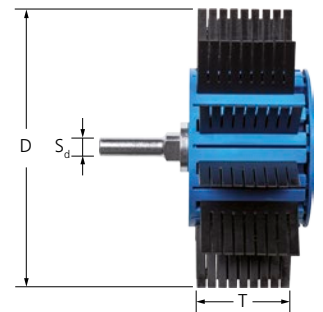

4

D [Inches]	T [Inches]	S _d [Inches]	EDP number	Opt. RPM	Max. RPM	
7	2-3/8	3/8	45950	1,500	3,500	1

POLIFLAP® abrasive flaps

Abrasive flaps for POLIFLAP® grinding wheels, for achieving visual effects ranging from coarse to very fine.

Advantages:

- Comfortable to use and easy to replace once worn.

Ordering notes:

- The packaging unit corresponds to a complete POLIFLAP® grinding wheel.

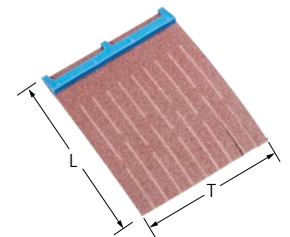

Abrasive:

Aluminum oxide A

L [Inches]	T [Inches]	Grit and EDP number								
		60	80	100	120	150	180	220	320	
2-3/8	3	45960	45961	45962	45963	45964	45965	45966	45968	12

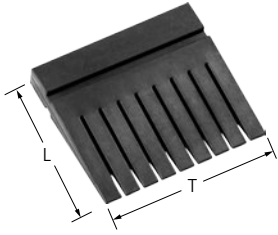

POLIFAP® rubber flaps

Rubber flaps to match the POLIFAP® grinding wheel. They lie between the abrasive flaps, and support the abrasive effect and the flexibility of the system.

Advantages:

- Comfortable to use as easy to replace once worn.

Ordering notes:

- The packaging unit corresponds to a complete POLIFAP® grinding wheel.

L [Inches]	T [Inches]	EDP number	
2	2	45951	12



POLISTAR-TUBE consists of multi-layered coated abrasive stars riveted together. They are designed specifically for working on the inner surfaces of pipes and pipe bends.

They are used in combination with the matching flexible shafts from catalogue section 9:

- For diameters 2" to 3-1/8" – 4 PST-T DIN 10/M4 (EDP 94264)
- For diameters 3-1/2" to 4" – 7 PST-T DIN 10/M5 (EDP 94274)

Advantages:

- Optimum adaptation to contours due to high flexibility.
- For achieving very fine surface quality grades of up to 8 µm (0.2 µm).
- Stainless steel rivets prevents contamination of stainless steel (INOX) workpieces.

Recommendations for use:

- For best performance, use with a recommended peripheral speed of 3,000–4,000 SFPM.
- Select the POLISTAR diameter based on the respective pipe's inner diameter:
 - Dia. 2" for inner pipe dia. 1-3/8"–1-5/8"
 - Dia. 2-1/4" for inner pipe dia. 1-5/8"–1-3/4"
 - Dia. 2-3/4" for inner pipe dia. 1-3/4"–2"
 - Dia. 3-1/8" for inner pipe dia. 2"–2-1/4"
 - Dia. 3-1/2" for inner pipe dia. 2-1/4"–2-3/8"
 - Dia. 4" for inner pipe dia. 2-3/8"–2-5/8"
- Select the appropriate grit size for the desired roughness value:
 - Grit size 60 = 39–51 µm (1.0 - 1.3 µm) R_a
 - Grit size 120 = 24–39 µm (0.6 - 1.0 µm) R_a
 - Grit size 180 = 16–24 µm (0.4 - 0.6 µm) R_a
 - Grit size 240 = 12–16 µm (0.3 - 0.4 µm) R_a
 - Grit size 320 = 8–12 µm (0.2 - 0.3 µm) R_a

Compatible power tools:

- Flexible shaft drives
- Straight grinders

Ordering notes:

- Please order arbors separately.
- POLISTAR-TUBE with a grit size of 60 are always supplied with 4 layers.

Safety notes:

- For safety reasons, the specified maximum permitted rotational speed must never be exceeded.



Accessories:

- Arbors for POLISTAR-TUBE

PFERDVALUE®:

PFERDERGONOMICS® recommends POLISTAR-TUBE to sustainably reduce vibration and noise levels during use and to improve working comfort.



POLISTAR-TUBE

POLISTAR-TUBE

Engineered for use in pipes and pipe bends.

Abrasive:

Aluminum oxide A

PFERDVALUE®:

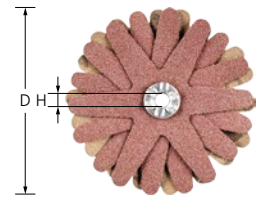

D [Inches]	H [mm]	No. of Layers	Grit and EDP number					Compatible arbor	Opt. RPM	Max. RPM	
			60	120	180	240	320				
2	4	6	44015	44016	44017	44018	44019	44062	3,000	7,650	10
2-1/4	4	6	44020	44021	44022	44023	44024	44062	2,500	6,350	10
2-3/4	4	6	44025	44026	44027	44028	44029	44062	2,200	5,450	10
3-1/8	4	6	44030	44031	44032	44033	44034	44062	1,900	4,750	10
3-1/2	5	8	44035	44036	44037	44038	44039	44063	1,700	4,250	10
4	5	8	44040	44041	44042	44043	44044	44063	1,500	3,820	10

Flap wheels

Arbors for POLISTAR-TUBE

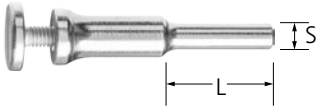

Arbors for POLISTAR-TUBE

Matching arbor for POLISTAR-TUBE.

Advantages:

- High productivity as the consumable can be changed quickly.

Fits arbor hole size [mm]	S [Inches]	L [Inches]	Clamping width [Inches]	EDP number	
4	1/4	1	0 - 3/8	44062	1
5	1/4	1	0 - 3/8	44063	1



Grinding products for work on metallic and non-metallic workpieces are sub-divided into three groups:

- **Bonded abrasives**
(e.g. grinding discs)
- **Flexible abrasives**
(e.g. belts, discs, strips, rolls) These products are used for coarse, fine and very fine grinding, in addition to stock removal.
- **Non-woven abrasives**
This group is primarily designed for surface structuring and conditioning.

Non-woven abrasives consist of polyamide fibres, synthetic resins and abrasive grain.

The non-woven fibre structure is impregnated or interspersed with resin and abrasive grain. The very loose connection between the individual fibres ensures a high level of flexibility and gives a strong spring-type effect to the non-woven material. It is flexible and supple, and leaves behind a very distinctive surface structure.

The satin-finished grinding result is unique and cannot be achieved with other abrasives. The consistent distribution of the abrasive grain in the non-woven structure guarantees a continuous supply of new, fresh and sharp abrasive grain throughout the entire grinding application.

Although non-woven abrasives have a completely differently structure to coated abrasives, the same abrasive materials are used for both groups of products:

- Aluminum oxide (Al_2O_3) is very durable, features an extremely long service life and has very high aggressiveness on hardened steel. The achieved surface finish is distinguished by its increased shine. Discolouration is prevented when working on aluminum.
- Silicon carbide (SiC) is even sharper, harder and cuts very easily. In no time at all, it produces a finer grinding pattern on the surfaces of many materials which remains slightly matte for a long time.

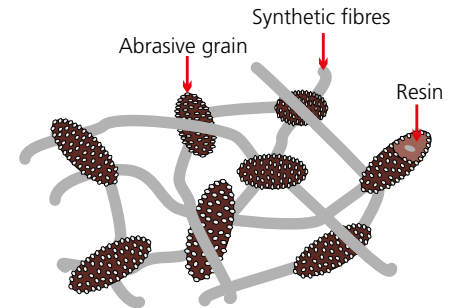

The user selects a specific grit size for conventionally bonded abrasives or coated abrasives. The designation system for non-woven abrasives is outlined in the following table:

PFERD designation	Comparable grit size [mesh]
Very coarse	50– 80
Coarse	80–100
Medium	100–180
Fine	180–220
Very fine	220–400



Use

The use of non-woven abrasives begins where other grinding products reach their limits or no longer achieve the desired results. The elastic properties of the polyamide fibres and the positive effect of the non-woven abrasives result in finishing products which produce outstanding results yet work gently.

Non-woven abrasives are water-tight, washable and very durable. They don't load, leave no rust behind on surfaces and are non-conductive.

Non-woven abrasive can be used to outstanding effect for deburring, cleaning and for work on the surfaces of many metals, including aluminum, brass, copper, nickel, stainless steel (INOX) and titanium. It is also ideal for work on other materials which are difficult to grind, such as ceramic, glass and plastic. Non-woven abrasive can be used for wet or dry grinding.

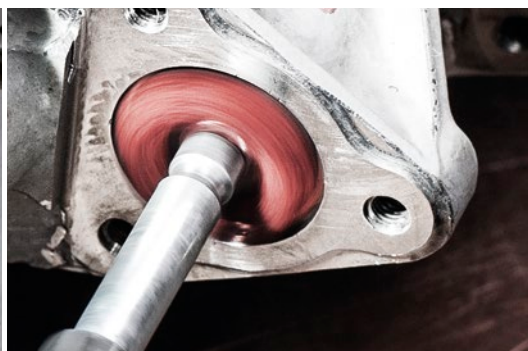

Non-woven products

General information

Non-woven products

Non-woven abrasives are recommended for manufacturing a wide range of different products, such as hand pads, drums, discs, belts, points and mounted grinding wheels.

The abrasive properties of these products are tailored to a variety of applications and represent outstanding solutions for numerous metal machining and processing tasks.

The PFERD range comprises:

- COMBICLICK®/COMBIDISC® non-woven discs
- Non-woven shop rolls, hand pads
- POLINOX® mounted flap wheels, grinding discs, grinding wheels and finishing drums

Additional types





Non-woven abrasive can also be manufactured with a fabric reinforcement. The non-woven abrasive material gains considerably higher aggressiveness and stability as a result.

Fabric-reinforced, non-woven abrasive is ideal for manufacturing discs and non-woven belts.

The PFERD range comprises:

- COMBICLICK®/COMBIDISC® non-woven discs
- POLIVLIES® flap discs and hook and loop discs
- Abrasive belts, non-woven type

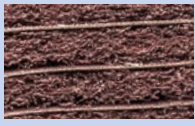

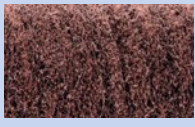
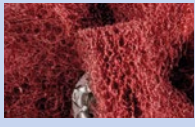

PFERD designation

Unitized PNER		<p>Due to different combinations of compaction, fibres, grain and the appropriate bond, this product can be used for a wide range of surface finishing applications, from relatively coarse grinding to preparing the surface for polishing.</p>
Convolute PNK		<p>The non-woven abrasive is wound around a core and foamed up. The products can be optimized for a variety of applications by implementing different foam, fibre, grain and bond combinations. The spectrum of application ranges from fine deburring through to preparations for polishing.</p>
Radial construction PNL		<p>Made of radially arranged flaps of non-woven abrasive material. The flaps are very tightly packed, which achieves a longer service life. The flap wheel's main application is surface work.</p>
Interleaved construction PNZ		<p>The non-woven abrasive is arranged in multiple radial flaps, with one abrasive cloth interlayer between each set of flaps. This flap combination facilitates greater stock removal and a coarser surface finish.</p>
Corrugated construction PNG		<p>The non-woven abrasive comprises several very wavy strips of non-woven material wound around a core. The wavy structure of the non-woven material permits seamless brush matting of surfaces.</p>
Axial- layered construction PNR		<p>The non-woven abrasive is arranged in multiple (axial) disc layers. Since the individual non-woven discs are not interconnected, the abrasive surface adapts easily to different workpiece contours, e.g. when working on profiles or pipes.</p>
Cross buffs PNST		<p>The non-woven abrasive is star-shaped and stacked in layers which are connected in the centre. It offers outstanding performance, specifically when used for tight work areas such as holes, recesses and hard-to-reach places.</p>

POLINOX® unitized wheels and discs consist of multiple heavily compressed, non-woven layers, which are bonded together by a special grain/resin system.





This particular bond results in non-woven products with a very good surface finish, high stock removal rate and long service life. These properties are particularly apparent when deburring, blending, finishing and polishing soft metals, alloyed and high-alloy steels, in addition to titanium alloys.

Four different types are available:

Type	Colour code	Properties
Soft		Soft variant with outstanding adaptability. At the same time, durability, abrasive performance and very high surface quality are all maintained. Ideally suited to machining contours.
Medium-soft		Medium-soft variant with increased edge strength and extended service life, for tough blending and polishing applications. Well suited to machining contours.
Medium-hard		Medium-hard variant with increased edge strength and extended service life, for tough deburring and cleaning applications.
Hard		Hard variant with very high stock removal rate, good edge strength and long service life, for tough deburring and polishing applications.



Comparison table

PFERD Unitized wheels				3M	Standard Abrasives	Norton	BIBIELLE
Type	Colour code	Abrasive	Grain				
Soft		SiC	Fine	EXL 2S fine	532	UW1-2SF or Nex-2SF	BUH 2SF
		A	Coarse	EXL 2A medium	521	UW1-2AM or Nex-2AM	BUH 2AM
Medium-soft		SiC	Fine	EXL 4S fine or SST 3S fine	632	UW1-4SF	BUH 3SF
		A	Fine	EXL 4A fine or SST 3A fine	631	UW1-4AF	-
Medium-hard		A	Fine	Cut & polish 5A fine or SST 5A fine	731	UW1-6AF or Nex-6AF	-
Hard		A	Fine	Cut & polish 7A medium or 9A medium	821	UW1-8AM or Nex-8AM	BUH 6AM
		A	Coarse	Cut & polish 7A coarse or 9A coarse	811	UW1-8AC or Nex-8AC	BUH 8AC



Non-woven products

General information – POLINOX® unitized wheels and discs

Advantages:

- Increased economic efficiency due to high abrasive performance and long service life.
- For achieving very good surface quality standards.
- Perfect adaptation to contours due to free profiling.

Workpiece materials:

- Can be used on nearly all materials.

Applications:

Cleaning

- Universal cleaning before painting.
- Removal of rust, scratches, coatings, heavy scaling, oxide layers of aluminum and heat discoloration.

Deburring

- Deburring of gear components, aircraft wing spars and turbine blade edges.
- Removal of heavy burrs, in addition to moderate blemishes and scratches.
- Edge breaking and rounding.

Blending

- Blending and finishing work on engine blade surfaces, turbine blades and rotor blades.
- Removal of smaller blemishes, scratches and joints on cast workpieces.

Polishing

- Polishing of fillet welds on turbine blades and aircraft parts.
- Polishing of soft metals before the coating process, and of hardened steel when repairing molds and dies.
- Polishing and finishing of surgical instruments and implants.

Recommendations for use:

- Considerably reduce peripheral speed for work on materials with poor heat-conducting properties, e.g. titanium and stainless steel.
- For best performance, use at a recommended peripheral speed of 3,000–6,900 SFPM. This provides an ideal compromise between stock removal rate, surface quality, thermal load on the workpiece and unitized wheel wear.

Compatible power tools:

- Flexible shaft drives
- Straight grinders
- Bench grinders

Safety notes:

- For safety reasons, the specified maximum permitted rotational speed must never be exceeded.



Accessories:

- Arbor for POLINOX® unitized wheels

PFERDVALUE®:

PFERDERGONOMICS® recommends POLINOX® unitized wheels and unitized discs to sustainably reduce vibration, noise and dust levels produced by products and to improve working comfort.

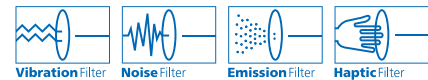

Recommended rotational speed range

Example:

EDP 48288, 3" POLINOX® unitized wheel
Peripheral speed: 5,000 SFPM

Rotational speed: 6,300 RPM

Wheel dia. [Inches]	Peripheral speed [SFPM]						
	3,000	4,000	5,000	6,000	6,300	7,000	9,900
	Rotational speeds [RPM]						
1	11,400	15,200	19,000	22,900	24,400	26,700	38,100
2	5,700	7,600	9,500	11,400	12,200	13,300	19,000
3	3,800	5,000	6,300	7,600	8,100	8,900	12,700
4	2,800	3,800	4,700	5,700	6,100	6,600	9,500
4-1/2	2,400	3,300	4,100	4,900	5,300	5,800	8,300
5	2,200	3,000	3,800	4,500	4,800	5,300	7,600
6	1,900	2,500	3,100	3,800	4,000	4,400	6,300



POLINOX® unitized wheels

Type for straight grinders, flexible shafts and bench grinders:
Ideal for work on smaller surfaces.

Type for variable-speed angle grinders and fillet weld grinders:
They are ideal for work on fillet welds and very hard-to-reach slots or indentations.

Abrasive:
Aluminum oxide A
Silicon carbide SiC

PFERD designation:
PNER

PFERDVALUE®:

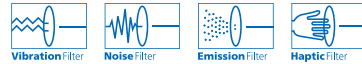

Recommendations for use:

- Grinding wheels with a 6-inch diameter can also be used on bench grinders, such as for reworking surgical instruments.



D [Inches]	T [Inches]	H [Inches]	Abrasive	Grit size	Hardness	Spec.	EDP number	Opt. RPM	Max. RPM	Compatible arbors			
Unitized wheels for straight grinders, flexible shaft machines, and bench grinders													
2	1/8	1/4	A	fine	H	8AM	48268	9,500	15,300	69029	10		
3	1/8	1/4	A	fine	H	8AM	48288	6,400	10,200	69029	10		
			A	coarse	W	2AM	48247	6,400	10,200	69029	10		
			A	fine	MH	6AF	48248	6,400	10,200	69029	10		
			A	coarse	H	8AC	48249	6,400	10,200	69029	10		
			SiC	fine	W	2SF	48245	6,400	10,200	69029	10		
			SiC	fine	MW	3SF	48246	6,400	10,200	69029	10		
	1/4	1/4	SiC	fine	W	2SF	48290	6,400	10,200	69029	5		
			A	coarse	W	2AM	48291	6,400	10,200	69029	5		
			SiC	fine	MW	3SF	48292	6,400	10,200	69029	5		
			A	fine	MW	3AF	48293	6,400	10,200	69029	5		
			A	fine	MH	6AF	48295	6,400	10,200	69029	5		
			A	coarse	H	8AC	48299	6,400	10,200	69029	5		
			1/2	1/4	SiC	fine	W	2SF	48310	6,400	10,200	69029	5
					A	coarse	W	2AM	48311	6,400	10,200	69029	5
SiC	fine	MW			3SF	48312	6,400	10,200	69029	5			
A	fine	MW			3AF	48313	6,400	10,200	69029	5			
A	fine	MH			6AF	48315	6,400	10,200	69029	5			
A	coarse	H			8AC	48319	6,400	10,200	69029	5			
6	1	1	SiC	fine	W	2SF	48420	3,200	5,100	45714	1		
			SiC	fine	MW	3SF	48422	3,200	5,100	45714	1		
			A/O	fine	MW	3AF	48423	3,200	5,100	45714	1		
			A/O	fine	MH	6AF	48425	3,200	5,100	45714	1		
			A/O	coarse	H	8AC	48429	3,200	5,100	45714	1		

Unitized wheels for variable-speed angle grinders, and fillet weld grinders

5	1/4	7/8	SiC	fine	MW	3SF	48352	4,500	6,100	-	5
			A	fine	MW	3AF	48353	4,500	6,100	-	5
			A	fine	MH	6AF	48355	4,500	6,100	-	5
			A	fine	H	8AM	48358	4,500	6,100	-	5
			A	coarse	H	8AC	48359	4,500	6,100	-	5
6	1/8	1	SiC	fine	MW	3SF	48360	3,800	5,100	-	5
			SiC	fine	MH	6SF	48361	3,800	5,100	-	5
			A	fine	H	8AM	48362	3,800	5,100	-	5
	1/4	1	SiC	fine	W	2SF	48363	3,800	5,100	-	5
			SiC	fine	MW	3SF	48364	3,800	5,100	-	5
			A	fine	H	8AM	48365	3,800	5,100	-	5



Non-woven products

Arbors for POLINOX® unitized wheels

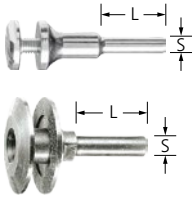

Arbors for POLINOX® unitized wheels

Matching arbor for POLINOX® unitized wheels.

Advantages:

- Increased economic efficiency as the arbor can be changed quickly.

Fits arbor hole size [Inches]	S [Inches]	L [Inches]	Clamping width [Inches]	EDP number	
1/2	1/4	1	1/8-1/4	69029	1
1	1/2	1-1/2	1-2	45714	1

POLINOX® unitized discs



POLINOX® unitized discs

POLINOX® unitized discs are used for face-down grinding on variable-speed angle grinders. Especially well-suited to work on larger surfaces. The compressed, non-woven material is bonded to a glass-fabric base.

Abrasive:

Silicon carbide SiC

Ordering notes:

T = thickness

PFERD designation:

PNER

PFERDVALUE®:

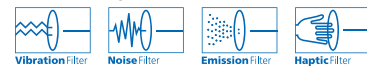





D [Inches]	T [Inches]	H [Inches]	Abrasive	Grit size	Hardness	Spec.	EDP number	Opt. RPM	Max. RPM	
Plain arbor hole										
4-1/2	1/2	7/8	SiC	fine	W	2SF	48470	6,000	10,000	5
						3SF	48472	6,000	10,000	5
						6SF	48474	6,000	10,000	5
5	1/2	7/8	SiC	fine	W	2SF	48480	5,400	10,000	5
						3SF	48482	5,400	10,000	5
						6SF	48484	5,400	10,000	5
Threaded hub										
4-1/2	1/2	5/8-11	SiC	fine	W	2SF	48490	6,000	10,000	5
						3SF	48492	6,000	10,000	5
						6SF	48494	6,000	10,000	5
5	1/2	5/8-11	SiC	fine	W	2SF	48500	5,400	10,000	5
						3SF	48502	5,400	10,000	5
						6SF	48504	5,400	10,000	5



POLINOX® convolute wheels consist of non-woven abrasive which is spiral-wound around a core and foamed up. The foam supports the non-woven component and improves its service life and abrasive performance.





This particular bond results in non-woven wheels with a very good surface finish, high stock removal rate and long service life. These properties are particularly apparent when deburring, blending, finishing and polishing soft metals, alloyed and high-alloy steels, in addition to titanium alloys. The wheels can be used on automated appliances and bench grinders, in addition to portable power tools such as straight grinders. By dressing the wheels, they can also be adapted to the geometry of special workpieces.

Five different types are available:

Type	Colour code	Properties
Soft		Soft variant with very good abrasive performance on contours. Very good for blending surfaces.
Medium-soft		Medium-soft variant with increased flexibility and extended service life for tough blending applications and for light deburring and polishing work. Well suited to machining contours.
Medium-hard		Medium-hard variant with increased edge strength and extended service life, for tough deburring applications and other deburring, blending and cleaning work.
Hard		Hard variant with very high stock removal rate, good edge strength and long service life, for moderate to heavy-duty deburring and polishing applications.
Extra-hard		Extra-hard variant with very high edge strength for demanding deburring work.



Comparison table

PFERD Convolute wheels				3M	Standard Abrasives	Norton	BIBIELLE
Type	Colour code	Abrasive	Grain				
Soft		A	Coarse	CP-WL 5AM	MF CV 5AM	MF CF 5AM	BCW-MF 5AM
Medium-soft		SiC	Fine	LDW 7SF	LDW 7SF	Series 2000 7SF	BCW-DB 7SF
Medium-hard		SiC	Fine	EXL Deburring 8SF	Deburring 8SF	Series 1000 8SF	BCW-DB 8SF
		A	Coarse	EXL Deburring 8AM	GP Plus 8AM	Series 1000 8AM	BCW-DB 8AM
Hard		SiC	Fine	Deburring 9SF	EXL Deburring 9SF	Series 1000 9SF	BCW-DB 9SF
Extra-hard		SiC	Fine	XP-WL 10SF	GP Plus 10SF	Series 4000 9SF	BCW-DB 9SF-R



Non-woven products

General information – POLINOX® convolute wheels

Advantages:

- Increased profitability due to high abrasive performance and long service life.
- For achieving very good surface quality standards.
- Perfect adaptation to contours due to free profiling.

Workpiece materials:

- Can be used on nearly all materials.

Abrasive:

- Aluminum oxide A
- Silicon carbide SiC

Applications:

- Rounding of edges.
- Fine grinding of implants.
- Matte finishing of flat surfaces.
- Removing joints on cast and forged parts.
- Weld dressing of intersections on turbine blades.
- Polishing molds and dies.
- Removal of processing traces on surgical instruments.

Recommendations for use:

- Considerably reduce peripheral speed for work on materials with poor heat-conducting properties, e.g. titanium and stainless steel.
- For best performance, use with a recommended peripheral speed of 4,000 SFPM. This provides an ideal compromise between stock removal rate, surface quality, thermal load on the workpiece and convolute wheel wear.

Compatible power tools:

- Flexible shaft drives
- Straight grinders
- Bench grinders

Safety notes:

- For safety reasons, the specified maximum permitted rotational speed must never be exceeded.
- The spiral-wound construction requires that these wheels only be run in a single indicated direction. Failure to do so will lead to destruction of the wheel and an increased risk of accidents.



PFERDVALUE®:

PFERDERGONOMICS® recommends POLINOX® convolute wheels to sustainably reduce vibration, noise and dust levels produced by products and to improve working comfort.

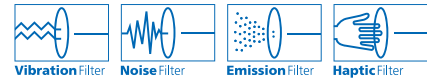

Recommended rotational speed range

Example:

EDP: 48200, 6 x 1/2 x 1

Peripheral speed: 4,000 SFPM

Rotational speed: 2,500 RPM

Wheel dia. [Inches]	Peripheral speed [SFPM]				
	3,000	4,000	5,000	6,000	8,000
Rotational speeds [RPM]					
6	1,900	2,500	3,100	3,800	5,000
8	1,400	1,900	2,400	2,900	3,800
10	1,100	1,500	1,900	2,200	3,000



POLINOX® convolute wheels

Varied application options, for example:

- Rounding of edges
- Fine grinding of implants
- Weld dressing of intersections on turbine blades
- Removal of processing traces on surgical instruments
- Create matte surface finishes.

PFERD designation:
PNK

PFERDVALUE®:



Abrasive:

- Aluminum oxide A
- Silicon carbide SiC

D [Inches]	T [Inches]	H [Inches]	Abrasive	Grit size	Hardness	Spec.	EDP number	Opt. RPM	Max. RPM	
6	1/2	1	SiC	fine	MW	7SF	48200	2,500	5,100	1
			A	coarse	MH	8AM	48201	2,500	5,100	1
			SiC	fine	MH	8SF	48202	2,500	5,100	1
			SiC	fine	H	9SF	48203	2,500	5,100	1
			SiC	fine	EH	10SF	48222	2,500	5,100	1
	1	1	A	coarse	W	5AM	48199	2,500	5,100	1
			SiC	fine	MW	7SF	48204	2,500	5,100	1
			A	coarse	MH	8AM	48205	2,500	5,100	1
			SiC	fine	MH	8SF	48206	2,500	5,100	1
			SiC	fine	H	9SF	48207	2,500	5,100	1
8	1/2	3	SiC	fine	MW	7SF	48208	1,900	3,850	1
			A	coarse	MH	8AM	48209	1,900	3,850	1
			SiC	fine	MH	8SF	48210	1,900	3,850	1
			SiC	fine	H	9SF	48211	1,900	3,850	1
			SiC	fine	EH	10SF	48224	1,900	3,850	1
	1	3	A	coarse	W	5AM	48220	1,900	3,850	1
			SiC	fine	MW	7SF	48212	1,900	3,850	1
			A	coarse	MH	8AM	48213	1,900	3,850	1
			SiC	fine	MH	8SF	48214	1,900	3,850	1
			SiC	fine	H	9SF	48215	1,900	3,850	1
	2	3	SiC	fine	EH	10SF	48225	1,900	3,850	1
			A	coarse	W	5AM	48221	1,900	3,850	1
			SiC	fine	MW	7SF	48216	1,900	3,850	1
			A	coarse	MH	8AM	48217	1,900	3,850	1
			SiC	fine	MH	8SF	48218	1,900	3,850	1
			SiC	fine	H	9SF	48219	1,900	3,850	1
			SiC	fine	EH	10SF	48226	1,900	3,850	1



Non-woven products

Reducing flanges for POLINOX® convolute wheels

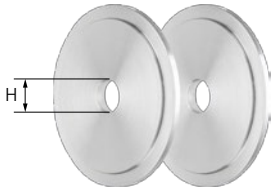

Reducing flanges for POLINOX® convolute wheels

For mounting POLINOX® convolute wheels with an 8" diameter on stationary machines such as double grinding machines (bench grinders).

Advantages:

- High accuracy of fit.
- Hole can be expanded as desired.

Ordering notes:

- Included in delivery: 1 pair

Fits arbor hole size [Inches]	H [Inches]	EDP number	
1	1/2	45720	1
	5/8	45721	1
	3/4	45722	1
3	5/8	45690	1
	1	45692	1
	1-1/4	45693	1



POLINOX® mounted and unmounted flap wheels and cross buffs consist of non-woven polyamide abrasive, into which abrasive grain is integrated.

The wide range of hardness grades and different configurations allow a variety of surface structures and roughness levels to be achieved.

Advantages:

- Optimum adaptation to contours due to high flexibility.
- Cool grinding and low thermal load of the workpiece.
- No loading due to open structure and high flexibility of the non-woven material.

Workpiece materials:

- Can be used on nearly all materials.

Recommendations for use:

- For best performance, use with a recommended peripheral speed of 2,000–4,000 SFPM. This provides an ideal compromise between stock removal rate, surface quality, thermal load on the workpiece and flap wheel/cross buff wear.

Accessories:

- Arbors for POLINOX® cross buffs and unmounted flap wheels

Safety notes:

- The maximum permitted peripheral speed is 6,300 SFPM.
- For safety reasons, the specified maximum permitted rotational speed must never be exceeded.



PFERDVALUE®:

PFERDERGONOMICS® recommends POLINOX® mounted and unmounted flap wheels to sustainably reduce vibration and noise levels during use and to improve working comfort.



Recommended rotational speed range

Example:

46223, Interleaved construction 4" mounted flap wheel

Peripheral speed: 3,000 SFPM

Rotational speed: 2,900 RPM

Wheel dia. [Inches]	Peripheral speed [SFPM]				
	2,000	3,000	4,000	6,000	6,300
Rotational speeds [RPM]					
3/4	10,200	15,300	20,400	30,600	32,100
1-1/2	5,100	7,600	10,200	15,300	16,000
2	3,800	5,700	7,600	11,500	12,000
2-1/2	3,100	4,600	6,100	9,200	9,600
4	1,900	2,900	3,800	5,700	6,000
5	1,500	2,300	3,100	4,600	4,800
6	1,300	1,900	2,500	3,800	4,000
8	1,000	1,400	1,900	2,900	3,000



Non-woven products

POLINOX® mounted flap wheels

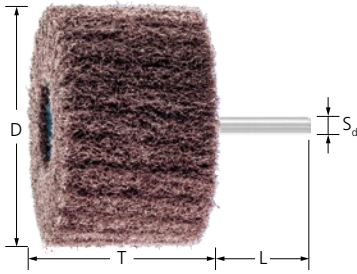

Radial construction

Made of radially arranged flaps of non-woven abrasive material. A long service life is achieved through the dense packing of the flaps.

This flap wheel is recommended for surface work.

Abrasive:
Aluminum oxide A

Compatible power tools:
flexible shaft drive, straight grinder

PFERD designation:
PNL

PFERDVALUE®:



D [Inches]	T [Inches]	S _d [Inches]	L [Inches]	Grit and EDP number			Opt. RPM	Max. RPM	
				100	180	280			
1	1	1/4	1-1/2	46198	46199	46200	10,000	20,000	10
1-1/2	3/4	1/4	1-1/2	46201	46202	46203	7,500	15,000	10
2	1	1/4	1-1/2	46204	46205	46206	6,000	12,000	10
2-3/8	2	1/4	1-1/2	46207	46208	46209	5,000	10,000	10
3	1	1/4	1-1/2	46251	46252	46253	4,000	7,500	10
	2	1/4	1-1/2	46210	46211	46212	4,000	7,500	10



Interleaved construction

The non-woven abrasive material is arranged in multiple radial flaps, with abrasive cloth interlayers.

This flap structure facilitates improved stock removal and achieves a coarser surface finish.

Abrasive:
Aluminum oxide A

Compatible power tools:
flexible shaft drive, straight grinder

PFERD designation:
PNZ

PFERDVALUE®:



D [Inches]	T [Inches]	S _d [Inches]	L [Inches]	Grit and EDP number		Opt. RPM	Max. RPM	
				100	180			
1	1	1/4	1-1/2	46196	46197	10,000	20,000	10
1-1/2	3/4	1/4	1-1/2	46219	46225	7,500	15,000	10
2	1	1/4	1-1/2	46220	46226	6,000	12,000	10
2-3/8	2	1/4	1-1/2	46221	46227	5,000	10,000	10
3	1	1/4	1-1/2	46269	46270	4,000	7,500	10
	2	1/4	1-1/2	46222	46228	4,000	7,500	10
4	2	1/4	1-1/2	46223	46229	3,000	6,000	10



Corrugated construction

Made of several wavyly arranged strips of non-woven abrasive material, wound around a core.

The wavy structure of the non-woven abrasive material permits seamless matte finishing of surfaces.

Abrasive:

Aluminum oxide A
Silicon carbide SiC

PFERD designation:

PNG

PFERDVALUE®:



Compatible power tools:

flexible shaft drive, straight grinder

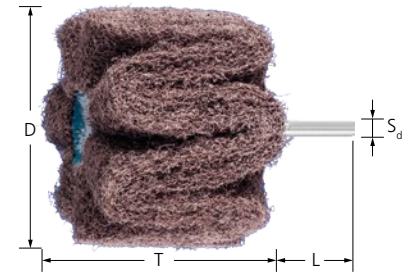

D [Inches]	T [Inches]	S _d [Inches]	L [Inches]	Grit and EDP number			Opt. RPM	Max. RPM	
				100	180	280			
Aluminum oxide A									
3	2	1/4	1-1/2	46236	46237	46238	4,000	7,500	10
4	2	1/4	1-1/2	46232	46230	46231	3,000	6,000	5
Silicon carbide (SiC)									
3	2	1/4	1-1/2	46239	46240	46241	4,000	7,500	10
4	2	1/4	1-1/2	46233	46234	46235	3,000	6,000	5

Axial-layered construction

The non-woven abrasive material is arranged in multiple (axial) disc layers.

Since the individual non-woven discs are not interconnected, the abrasive surface adapts easily to different workpiece contours, e.g. when working on profiles or pipes.

Abrasive:

Aluminum oxide A

PFERD designation:

PNR

PFERDVALUE®:



Compatible power tools:

flexible shaft drive, straight grinder

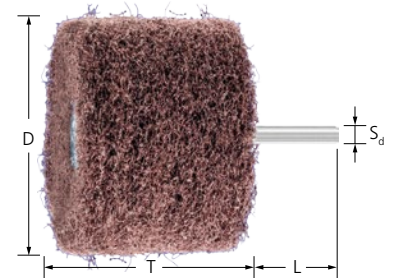

D [Inches]	T [Inches]	S _d [Inches]	L [Inches]	Grit and EDP number			Opt. RPM	Max. RPM	
				100	180	280			
2-3/8	2	1/4	1-1/2	46213	46214	46215	5,000	10,000	10
3	2	1/4	1-1/2	46216	46217	46218	4,000	7,500	10

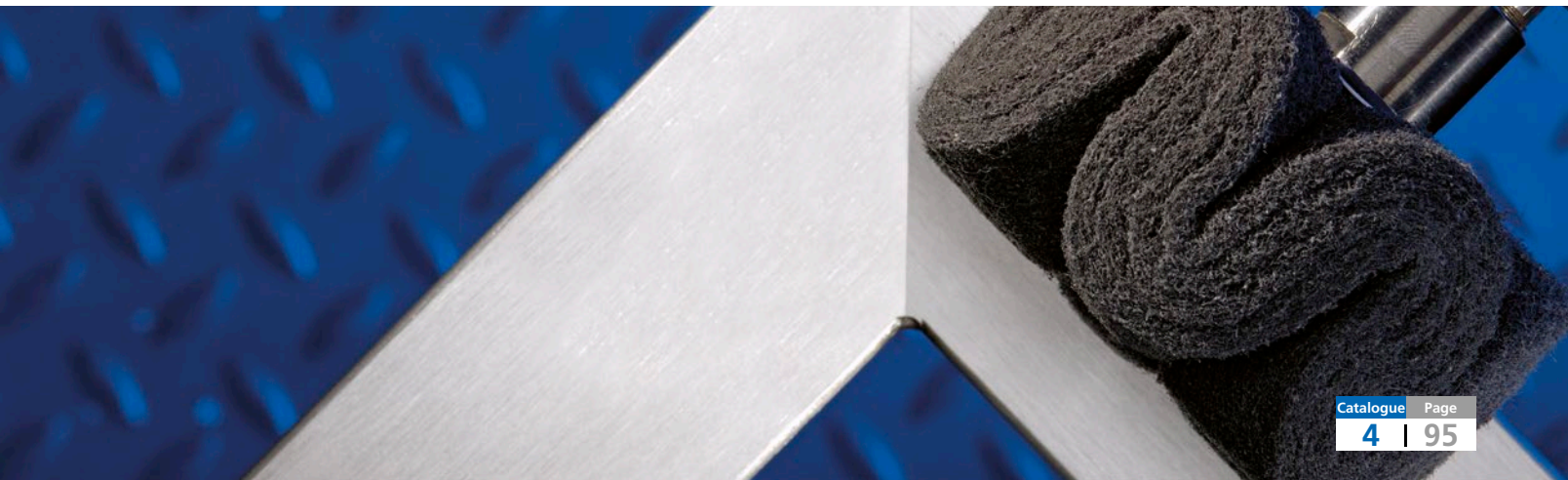

Non-woven products

POLINOX® cross buffs and accessories

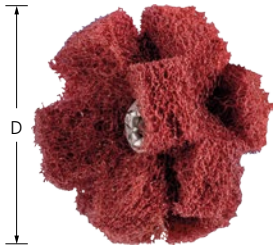

POLINOX® cross buffs

Ideal for cleaning, deburring and fine grinding of inner surfaces and contours. Highly recommended for hard-to-reach places such as drilled holes and indentations.

Abrasive:
Aluminum oxide A

PFERD designation:
PNST

Compatible power tools:
flexible shaft drive, straight grinder

PFERDVALUE®:



Ordering notes:

- Please order the matching arbor separately.

D [Inches]	No. of layers [pcs.]	Thread	Grit and EDP number			Compatible arbor	Opt. RPM	Max. RPM	
			80	100	280				
3/4	2	8-32	-	44198	44199	44830	15,000	25,100	20
1	2	8-32	44202	44200	44201	44830	10,000	19,100	20
1-1/2	3	8-32	44210	44208	44209	44830	7,500	12,600	20
2	2	8-32	44212	44213	44214	44830	5,500	9,500	20

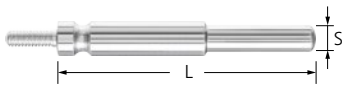

Drive arbor for POLINOX® cross buffs

Arbors for POLINOX® cross buffs.

Advantages:

- Increased economic efficiency due to quick cross buff changes.

S [Inches]	L [Inches]	Thread	Mounting length [Inches]	EDP number	Max. RPM	
1/4	3	8-32	1-1/4	44830	25,000	1

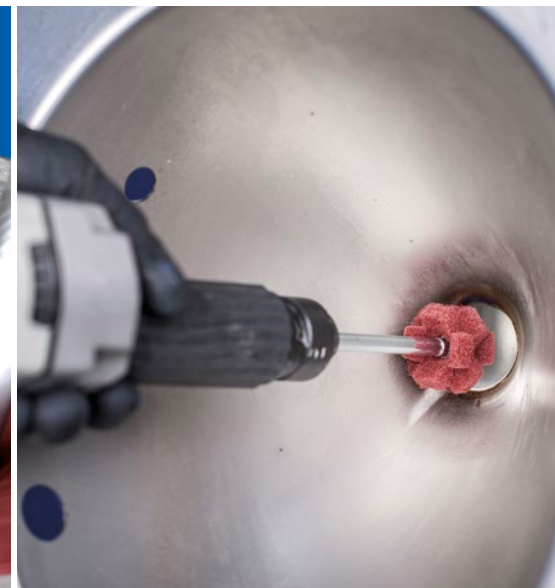
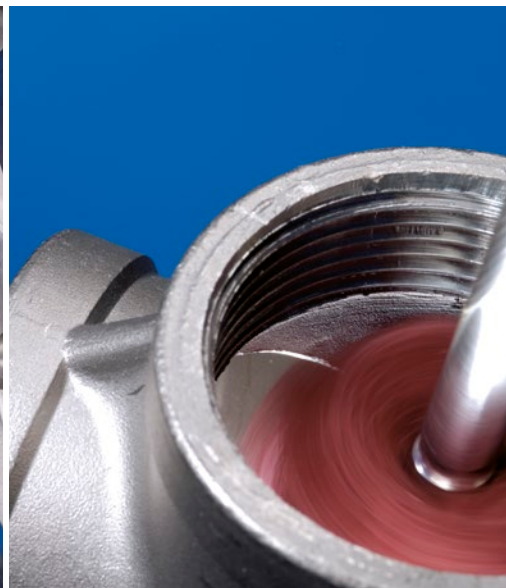

Radial construction

Made of radially arranged flaps of non-woven abrasive material. A long service life is achieved through the dense packing of the flaps.

This unmounted flap wheel is ideal for work on large surfaces.

Abrasive:

Aluminum oxide A

PFERD designation:

PNL

Compatible power tools:

flexible shaft drive, straight grinder, bench grinder

PFERDVALUE®:

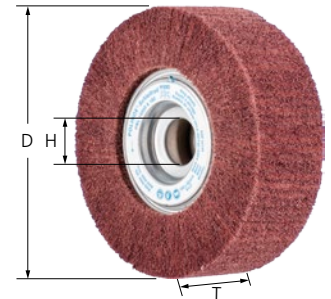

Ordering notes:

■ Please order the matching arbor separately.

D [Inches]	T [Inches]	H [Inches]	Grit and EDP number			Compatible arbor	Opt. RPM	Max. RPM	
			100	180	280				
6	2	1	43128	43129	43130	45714	2,000	4,000	1
8	2	1-3/4	43137	43138	43139	45715	1,500	3,000	1

Interleaved construction

The non-woven abrasive material is arranged in multiple radial flaps, with abrasive cloth interlayers. This flap structure facilitates improved stock removal and achieves a coarser surface finish.

This unmounted flap wheel is ideal for work on large surfaces.

Abrasive:

Aluminum oxide A

PFERD designation:

PNZ

Compatible power tools:

flexible shaft drive, straight grinder, bench grinder

PFERDVALUE®:

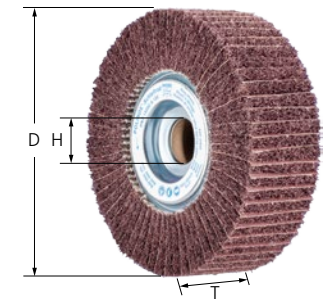

Ordering notes:

■ Please order the matching arbor separately.

D [Inches]	T [Inches]	H [Inches]	Grit and EDP number		Compatible arbor	Opt. RPM	Max. RPM	
			100	180				
6	2	1	43045	43046	45714	2,000	4,000	1
8	2	1-3/4	43048	43049	45715	1,500	3,000	1

Corrugated construction

Made of several wavy arranged strips of non-woven abrasive material, wound around a core.

The wavy structure of the non-woven abrasive material permits seamless matte finishing of surfaces.

Abrasive:

Aluminum oxide A

PFERD designation:

PNG

Compatible power tools:

flexible shaft drive, straight grinder, bench grinder

PFERDVALUE®:

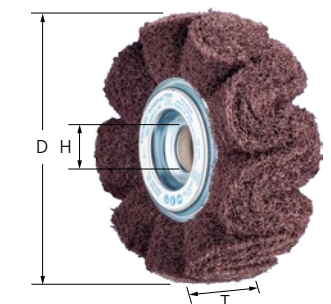

Ordering notes:

■ Please order the matching arbor separately.

D [Inches]	T [Inches]	H [Inches]	Grit and EDP number			Compatible arbor	Opt. RPM	Max. RPM	
			100	180	280				
6	2	1	43030	43031	43032	45714	2,000	4,000	1
8	2	1-3/4	43036	43037	43038	45715	1,500	3,000	1

Non-woven products

POLINOX® unmounted flap wheels and accessories

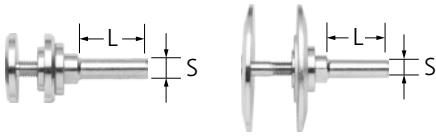

Drive arbors

Matching arbor for POLINOX® unmounted flap wheels.

Advantages:

- Increased economic efficiency due to quick flap wheel changes.

Fits arbor hole size [Inches]	S [Inches]	L [Inches]	Clamping width [Inches]	For wheel diameter [Inches]	EDP number	
1	1/2	1-1/2	1-2	4-6	45714	1
1-3/4	1/2	1-1/2	1-2	8-10	45715	1

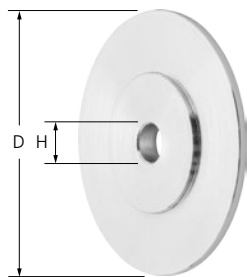

Reducing flanges

For mounting unmounted flap wheels and POLINOX® unmounted flap wheels on drive spindles. The clamping flanges are designed to lie countersunk in the flap wheel.

Advantages:

- Can be adapted to an existing drive spindle by drilling.
- Can be used face-down very close to edges and in angles due to special clamping system.

Ordering notes:

- Included in delivery: 1 pair

Fits arbor hole size [Inches]	D [Inches]	H [Inches]	Max. H [Inches]	For wheel diameter [Inches]	EDP number	
1	1-1/2	1/2	7/8	4-6	45720	1
	1-1/2	5/8	7/8	4-6	45721	1
	1-1/2	3/4	7/8	4-6	45722	1
1-3/4	3-1/4	1/2	1-1/2	8-10	45725	1
	3-1/4	5/8	1-1/2	8-10	45726	1
	3-1/4	3/4	1-1/2	8-10	45727	1
	3-1/4	1	1-1/2	8-10	45728	1

POLINOX® unmounted flap wheels, threaded

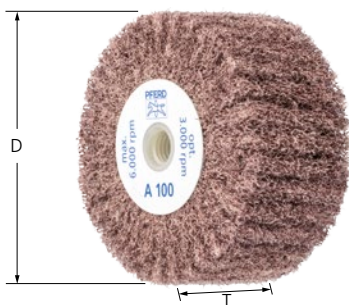

Radial construction

Made of radially arranged flaps of non-woven abrasive material. A long service life is achieved through the dense packing of the flaps.

The unmounted flap wheel is designed for working on medium-sized surfaces with variable-speed angle grinders and fillet weld grinders, and can be mounted directly onto the drive system's spindle without the need for additional clamping devices.

Abrasive:

Aluminum oxide A

Compatible power tools:

angle grinder, cordless angle grinder

Pferd designation:

PNL

PferdVALUE®:



D [Inches]	T [Inches]	Thread [Inches]	Grit and EDP number			Opt. RPM	Max. RPM	
			100	180	280			
4	2	5/8-11	43188	43189	43190	3,000	6,000	5

Interleaved construction

The non-woven abrasive material is arranged in multiple radial flaps, with abrasive cloth interlayers. This flap structure facilitates improved stock removal and achieves a coarser surface finish.

The unmounted flap wheel is designed for working on medium-sized surfaces with variable-speed angle grinders and fillet weld grinders, and can be mounted directly onto the drive system's spindle without the need for additional clamping devices.

Abrasive:

Aluminum oxide A

PFERD designation:

PNZ

Compatible power tools:

angle grinder, cordless angle grinder

PFERDVALUE®:

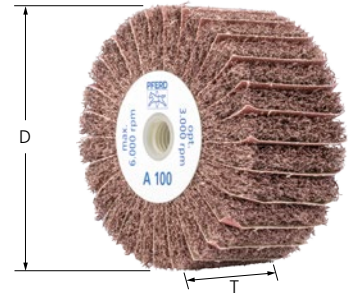

D [Inches]	T [Inches]	Thread [Inches]	Grit and EDP number		Opt. RPM	Max. RPM	
			100	180			
4	2	5/8-11	43013	43014	3,000	6,000	5

Corrugated construction

Made of several wavyly arranged strips of non-woven abrasive material, wound around a core. The wavy structure of the non-woven abrasive material permits seamless matte finishing of surfaces.

The unmounted flap wheel is designed for working on medium-sized surfaces with variable-speed angle grinders and fillet weld grinders, and can be mounted directly onto the drive system's spindle without the need for additional clamping devices.

Abrasive:

Aluminum oxide A

PFERD designation:

PNG

Compatible power tools:

angle grinder, cordless angle grinder

PFERDVALUE®:

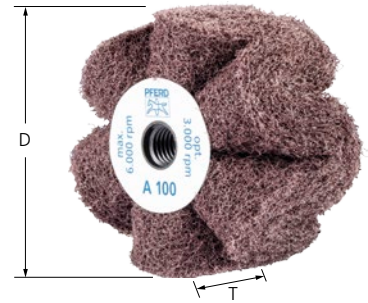

D [Inches]	T [Inches]	Thread [Inches]	Grit and EDP number			Opt. RPM	Max. RPM	
			100	180	280			
4	2	5/8-11	43024	43025	43026	3,000	6,000	5
5	2	5/8-11	43107	43108	43109	2,300	4,900	1

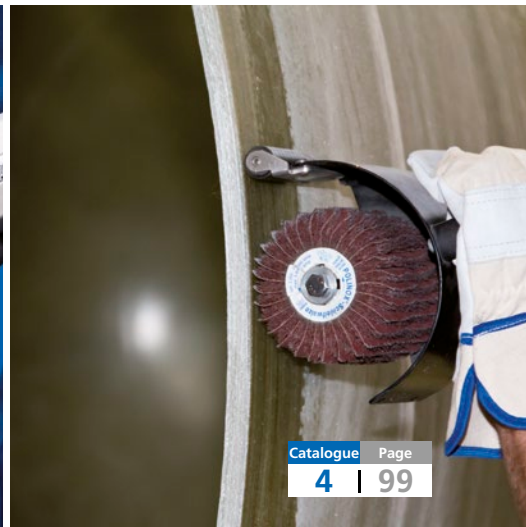

Non-woven products

General information – POLINOX® finishing drums

POLINOX® finishing drums are especially suited to work on flat surfaces.

Advantages:

- Long service life due to tightly packed flaps.
- Cool grinding and low thermal load of the workpiece.
- No loading due to open structure and high flexibility of the non-woven material.

Workpiece materials:

- Can be used on nearly all materials.



Applications:

- Roughing
- Deburring
- Surface work
- Cleaning
- Structuring (matte finishing and satin finishing)
- Step-by-step fine grinding

Compatible power tools:

- Drum grinders

Ordering notes:

- The 3/4" centre hole diameter with 4 keyways fits all conventional drum grinders.
- Additional drum products can be found on pages 45, 78 and 120, as well as in catalogue section 8.

Safety notes:

- For safety reasons, the specified maximum permitted rotational speed must never be exceeded.



PFERDVALUE®:

PFERDERGONOMICS® recommends POLINOX® finishing drums to sustainably reduce vibration and noise levels during use and to improve working comfort.



POLINOX® finishing drums

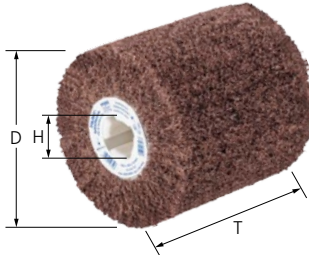

Radial construction

Made of radially arranged flaps of non-woven abrasive material. A long service life is achieved through the dense packing of the flaps.

Abrasive:

Aluminum oxide A

PFERD designation:

PNL

PFERDVALUE®:



D [Inches]	T [Inches]	Bore/ Thread [Inches]	Grit and EDP number				Opt. RPM	Max. RPM	
			80	100	180	280			
4	4	3/4	43102	43103	43104	43105	2,500	4,800	1
5	4	5/8-11	-	46786	46787	46788	2,300	3,100	1



Interleaved construction

Made of radially arranged flaps of non-woven abrasive material. There is also abrasive cloth situated between the flaps. The flap structure facilitates improved stock removal and achieves a coarser surface finish.

Abrasive:

Aluminum oxide A

PFERD designation:

PNZ

PFERDVALUE®:

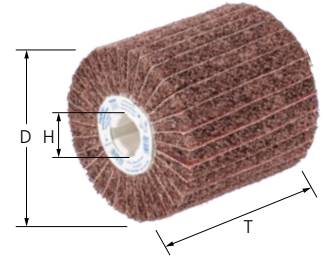

D [Inches]	T [Inches]	Bore/ Thread [Inches]	Grit and EDP number			Opt. RPM	Max. RPM	
			60	80	120			
4	4	3/4	43113	43114	43115	2,500	4,800	1
5	4	5/8-11	46789	46790	46791	2,300	3,100	1

Corrugated construction

Made of several wavy arranged strips of non-woven abrasive material, wound around a core. The wavy structure of the non-woven abrasive material permits seamless brush matting of large surfaces.

Abrasive:

Aluminum oxide A

PFERD designation:

PNG

PFERDVALUE®:



D [Inches]	T [Inches]	Bore [Inches]	Grit and EDP number			Opt. RPM	Max. RPM	
			100	180	280			
4	4	3/4	43003	43004	43005	2,000	4,800	1

Linear finishing set

Linear finishing set

Complete linear finishing set for rough grinding to surface finishing. Set features linear finishing tool, as well as a selection of coated grinding belts, POLIVLIES® non-woven surface conditioning belts, and POLINOX® non-woven finishing drums. Pneumatic drum holder for belts also included.

Contents of the linear finishing set:

1 pc. each of:

- EDP 91217 – linear finishing tool, UWER 15/35 SI D19 120V
- EDP 49985 – 3-1/2" x 15-1/2" pneumatic drum 5/8-11 thread
- EDP 49986 – threaded spindle extension for pneumatic drum
- EDP 46790 5 x 4" POLINOX® interleaved grinding drum, 80 grit

2 pcs. each of:

- EDP 43613 – 3-1/2" x 15-1/2" POLIVLIES® non-woven belt, coarse grit
- EDP 43614 – 3-1/2" x 15-1/2" POLIVLIES® non-woven belt, medium grit
- EDP 43615 – 3-1/2" x 15-1/2" POLIVLIES® non-woven belt, fine grit

10 pcs. of:

- EDP 49314 – 3-1/2" x 15-1/2" coated belt A/O, 60 grit



Case dimensions [Inches]	EDP number	
6-1/3 x 10 x 22-4/5	49999	1

Non-woven products

POLINOX® fibre-backing discs



Radial construction

Non-woven abrasive flaps with a fibreglass backer, for face-down finishing work. Densely-stacked flaps for long service life.

The disc is designed for working on large surfaces with variable-speed angle grinders.

Abrasive:
Aluminum oxide A

Compatible power tools:
angle grinder, cordless angle grinder

Ordering notes:
T = thickness

PFERD designation:
PNL

PFERDVALUE®:



D [Inches]	T [Inches]	H [Inches]	Grit and EDP number			Opt. RPM	Max. RPM	
			100	180	280			
4-1/2	3/4	7/8	45891	45892	45893	2,500	5,300	5
5	3/4	7/8	45894	45895	45896	2,300	3,800	5



Interleaved construction

Interleaved abrasive and non-woven flaps with a fibreglass backer for face-down finishing work. Densely-stacked flaps for long service life and increased stock removal.

The disc is designed for working on large surfaces with variable-speed angle grinders.

Abrasive:
Aluminum oxide A

Compatible power tools:
angle grinder, cordless angle grinder

Ordering notes:
T = thickness

PFERD designation:
PNZ

PFERDVALUE®:



D [Inches]	T [Inches]	H [Inches]	Grit and EDP number		Opt. RPM	Max. RPM	
			100	180			
4-1/2	3/4	7/8	45911	45912	2,500	5,300	5
5	3/4	7/8	45915	45916	2,300	3,800	5

High-strength masking tape



High-strength masking tape

Used to create a clear separation between different grinding patterns in adjacent areas. The masking tape protects surfaces which have already been worked on, or which are not supposed to be worked on.

Advantages:

- 3/4" width: High elasticity and tear strength.
- 2" width: Reusable and extremely high durability.
- High edge stability.

Workpiece materials:
aluminum, stainless steel (INOX)

Recommendations for use:

- 3/4" width: Use only during finish machining with soft, flexible products, e.g. non-woven products.
- To avoid its inadvertent removal, ensure that the masking tape is only applied in the running direction of the tool.

L [Feet]	T [Inches]	EDP number	
82	3/4	43000	1
10	2	43001	1

PFERD supplies POLIVLIES® flap discs and hook and loop discs in various grit sizes, diameters and types. These are recommended for work on large surfaces made from stainless steel (INOX).

Advantages:

- Increased economic efficiency due to high abrasive performance and long service life.
- Creates a consistently high surface quality throughout the entire service life as new, sharp abrasive material is constantly exposed.
- Conforms to contours due to high flexibility.

Workpiece materials:

- Can be used on nearly all materials.

Compatible power tools:

- Angle grinders
- Cordless angle grinders

Ordering notes:

T = thickness

Safety notes:

- The specified maximum permitted rotational speed must never be exceeded.

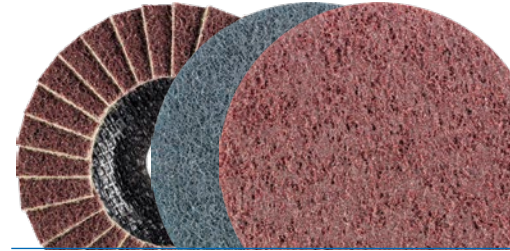

Aluminum oxide A

For universal coarse to fine grinding applications in industry and professional trades.

Abrasive:

Aluminum oxide A
Available POLIVLIES® grit sizes:
100 C = coarse (yellow-brown)
180 M = medium (red-brown)
240 F = fine (blue)

Recommendations for use:

- For the best results, use at a recommended peripheral speed of 6,000–6,900 SFPM.

PFERD designation:

PVL



4



D [Inches]	T [Inches]	H [Inches]	Grit, type and EDP number			Opt. RPM	Max. RPM	
			100 C	180 M	240 F			
Plain arbor hole								
4-1/2	3/4	7/8	43273	43274	43275	5,000–5,800	13,300	5
5	3/4	7/8	43276	43277	43278	4,600–5,300	12,200	5
Threaded hub								
4-1/2	3/4	5/8-11	43285	43286	43287	5,000–5,800	13,300	5
5	3/4	5/8-11	43288	43289	43290	4,600–5,300	12,200	5

Ceramic oxide CO-COOL

For aggressive grinding with maximum stock removal rate on hard materials which do not conduct heat well. Consistently high performance due to self-sharpening ceramic oxide grain. Active grinding additives in the coating substantially improve the stock removal rate, prevent loading and result in cooler grinding.

Abrasive:

Coated abrasive flaps: Ceramic oxide CO-COOL
Non-woven material: Aluminum oxide A
Available POLIVLIES® grit sizes:
100 C = coarse (yellow-brown)
180 M = medium (red-brown)
240 F = fine (blue)

Recommendations for use:

- For the best results, use at a recommended peripheral speed of 6,000–6,900 SFPM

PFERD designation:

PVZ



D [Inches]	T [Inches]	H [Inches]	Grit, type and EDP number			Opt. RPM	Max. RPM	
			CO-COOL 60 / A 100 C	CO-COOL 80 / A 180 M	CO-COOL 120 / A 240 F			
Plain arbor hole								
4-1/2	3/4	7/8	43297	43298	43299	5,000–5,800	13,300	5
5	3/4	7/8	43300	43301	43302	4,600–5,300	12,200	5
Threaded hub								
4-1/2	3/4	5/8-11	43309	43310	43311	5,000–5,800	13,300	5
5	3/4	5/8-11	43312	43313	43314	4,600–5,300	12,200	5

Non-woven products

POLIVLIES® hook and loop discs



POLIVLIES® hook and loop discs

POLIVLIES® hook and loop discs are suited to grinding large surfaces. The pre-punched holes mean that they can be ideally centred on and used with various backing pads.

Abrasive:

Aluminum oxide A
 Available POLIVLIES® grit sizes:
 100 C = coarse (yellow-brown)
 180 M = medium (red-brown)
 240 F = fine (blue)

Ordering notes:

■ Please order POLIVLIES® hook and loop disc holders separately.

PFERD designation:

PVKR

Recommendations for use:

- For the best results, use at a recommended peripheral speed of 3,000– 4,000 SFPM.
- Use with POLIVLIES® hook and loop disc holder.
- Break out the pre-punched centering hole if required.

D ₁ [Inches]	Grit, type and EDP number			Opt. RPM	Max. RPM	Compatible backing pad	
	100 C	180 M	240 F				
4-1/2	43446	43447	43449	3,300	5,300	43407	10
5	43450	43451	43453	3,000	4,850	43408	10
7	43458	43459	43461	2,200	3,500	43409	10

POLIVLIES® hook and loop disc holders



POLIVLIES® hook and loop disc holders

Backing pads for POLIVLIES® hook and loop discs.

Advantages:

- Increased economic efficiency as the discs can be changed quickly.
- Enables surface finishing without visible transitions.
- Centering pin enables faster central clamping.

D [Inches]	Thread [Inches]	EDP number	Max. RPM	
With centering pin				
4-1/2	5/8-11	43407	5,300	1
5	5/8-11	43408	4,850	1
7	5/8-11	43409	3,500	1
Without centering pin				
4-1/2	5/8-11	43410	5,300	1
5	5/8-11	43412	4,850	1
7	5/8-11	43420	3,500	1



POLICLEAN® PLUS is a coarsely structured, abrasive, non-woven cleaning fabric that was developed from a special combination of synthetic fibres and abrasive grain.

The comprehensive range of POLICLEAN® PLUS products contain:

- POLICLEAN® PLUS wheels
- POLICLEAN® PLUS mounted wheels
- COMBIDISC® POLICLEAN® PLUS discs (see COMBIDISC® discs, page 34)
- POLICLEAN® PLUS discs

Advantages:

- High flexibility and open structure mean ideal adaptation to contours and no loading of the product itself.
- The POLICLEAN® PLUS material exhibits considerably higher stock removal rates with a long service life, and is also very aggressive.

Workpiece materials:

- Can be used on nearly all materials.

Applications:

- Roughing
- Surface work
- Cleaning
- Removing heat discolouration
- Removing paint
- Derusting
- Descaling
- Removing oxidation

Abrasive:

- Aluminum oxide A

Recommendations for use:

- For best performance, use with a recommended peripheral speed of 3,000–4,000 SFPM. This provides an ideal compromise between stock removal rate, surface quality, thermal load on the workpiece and product wear.

Safety notes:

- For safety reasons, the specified maximum permitted rotational speed must never be exceeded.



4

Recommended rotational speed range

Example:

EDP: 44791, 4" POLICLEAN® PLUS wheel

Peripheral speed: 3,000–4,000 SFPM

Rotational speed: 2,900–3,800 RPM

Wheel dia. [Inches]	Peripheral speed [SFPM]				
	2,000	3,000	4,000	6,000	8,000
Rotational speeds [RPM]					
3	2,500	3,800	5,100	7,600	10,200
4	1,900	2,900	3,800	5,700	7,600
4-1/2	1,700	2,500	3,400	5,100	6,800
5	1,500	2,300	3,100	4,600	6,100
6	1,300	1,900	2,500	3,800	5,100



Non-woven products

POLICLEAN® PLUS products

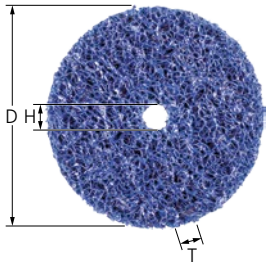

POLICLEAN® PLUS wheels

For coarse cleaning work such as removing paint, scale, heat discoloration, rust and adhesive residues in peripheral grinding.

POLICLEAN® PLUS discs exhibit a higher stock removal rate with a very long service life.

Recommendations for use:

- For work on larger surfaces, pack several POLICLEAN® PLUS wheels with the appropriate arbor.

Compatible power tools:

flexible shaft drive, power drill, straight grinder

Ordering notes:

- Please order the matching arbor separately.

D [Inches]	T [Inches]	H [Inches]	EDP number	Opt. RPM	Max. RPM	
3	1/2	1/4	44790	4,000–5,100	10,000	6
4	1/2	1/2	44791	3,000–3,800	7,500	4
6	1/2	1/2	44792	2,000–2,500	5,100	4

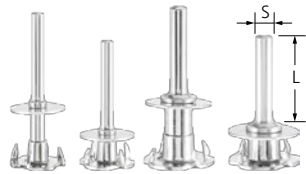

Drive arbors for POLICLEAN® PLUS wheels

Arbors for POLICLEAN® PLUS wheels. The different variants provide space for 1 or 2 wheels.

Advantages:

- Increased economic efficiency due to quick wheel changes.

Recommendations for use:

- When replacing the wheels, leave the arbor clamped in the power tool.

Fits arbor hole size [Inches]	S [Inches]	L [Inches]	Compatible POLICLEAN® PLUS wheel	EDP number	No. of wheels	
1/2	1/4	1-1/2	44790, 44791, 44972	44835	1 wheel	1
	1/4	1-1/2	44790, 44791, 44972	44836	2 wheels	1
	3/8	1-1/2	44790, 44791, 44972	44838	1 wheel	1
	3/8	1-1/2	44790, 44791, 44972	44839	2 wheels	1





POLICLEAN® PLUS mounted wheels

For coarse cleaning work such as removing paint, scale, heat discoloration, rust and adhesive residues in peripheral grinding.

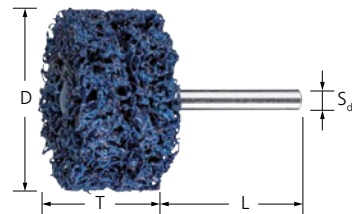

Compatible power tools:
flexible shaft drive, power drill, straight grinder



D [Inches]	T [Inches]	S _d [Inches]	L [Inches]	EDP number	Opt. RPM	Max. RPM	
2	1/2	1/4	1-1/2	44884	6,000–7,000	15,000	5
	1	1/4	1-1/2	44885	6,000–7,000	15,000	5
3	1/2	1/4	1-1/2	44886	4,000–5,100	10,000	5
	1	1/4	1-1/2	44887	4,000–5,100	10,000	5
4	1/2	1/4	1-1/2	44888	3,000–3,800	7,500	5

POLICLEAN® PLUS discs

The non-woven cleaning material is glued to a fibreglass backer. This makes POLICLEAN® PLUS discs ideal for use in face-down grinding.

For coarse cleaning work such as removing paint, scale, heat discoloration, rust and adhesive residues.

POLICLEAN® PLUS discs exhibit a high stock removal rate with a very long service life.





Recommendations for use:

- Preferably for use on slow-running angle grinders.
- For the best results, use at a recommended peripheral speed of 6,000–6,900 SFPM.

Compatible power tools:
angle grinder, cordless angle grinder

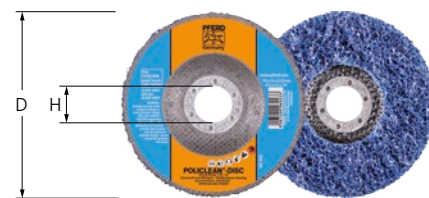
Ordering notes:
T = thickness



D [Inches]	T [Inches]	H [Inches]	EDP number	Opt. RPM	Max. RPM	
Plain arbor hole						
4-1/2	1/2	7/8	44874	5,000–7,000	10,000	5
5	1/2	7/8	44875	5,000–7,000	10,000	5
Threaded hub						
4-1/2	1/2	5/8-11	44879	5,000–7,000	10,000	5
5	1/2	5/8-11	44880	5,000–7,000	10,000	5

Poliflex® finishing points

General information

Poliflex® finishing points are manufactured with high shape accuracy, consistent quality and tight dimensional tolerances.

They are ideal for fine grinding, structuring and preparations for polishing work, and are very frequently used for tool and die making applications.

Advantages:

- For achieving very high surface quality standards.
- High productivity due to long service life and very high stock removal rate.
- Excellent working comfort due to precise concentricity.



Applications:

- Structuring (matte finishing, brush matting and satin finishing)
- Step-by-step fine grinding

Recommendations for use:

- Depending on the application, profile with a diamond dresser or with ceramic dressing stones at a low rotational speed. Please refer to catalogue section 3 for detailed information and ordering data for dressing products.

Explanation of the code system according to EN 12413:

- D = Grinding point outer diameter
- T = Grinding point width
- S_d = Shank diameter
- L_0 = Unsupported shank length
- L_2 = Shank length
- L_3 = Clamping length of shank

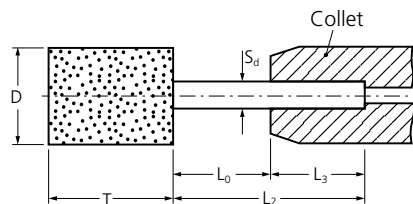

Safety notes:

The following maximum operating speeds are permitted for Poliflex® finishing points:

GR	3,000 SFPM
LR	6,000 SFPM

- The maximum rotational speeds for the various shank lengths and shank diameters are defined in DIN 69170 based on EN 12413. These must be adhered to in order to avoid buckling of the shank during use. Regardless of the shank length, the clamping length (L_3) of the shank must be at least 1/2".
- Each packaging unit of PFERD finishing points comes with rotational speed specifications for the unsupported shank length (L_0) of that wheel. Proper concentric accuracy and correct clamping of the power tool must also be ensured.



Recommended rotational speed range

Example:

EDP 36491, A21 120 grit, rubber bond
Poliflex® dia.: 1"
Peripheral speed: 3,000 SFPM
Rotational speed: 11,500 RPM

Finishing point dia. [Inches]	Peripheral speed [SFPM]					
	2,000	2,400	3,000	4,000	5,000	6,000
	Rotational speeds [RPM]					
1/4	30,600	36,700	45,800	61,100	76,400	91,700
5/16	24,400	29,300	36,700	48,900	61,100	73,300
3/8	20,400	24,400	30,600	40,700	50,900	61,100
1/2	15,300	18,300	22,900	30,600	38,200	45,800
5/8	12,200	14,700	18,300	24,400	30,600	36,700
11/16	11,100	13,300	16,700	22,200	27,800	33,300
3/4	10,200	12,200	15,300	20,400	25,500	30,600
7/8	8,700	10,500	13,100	17,500	21,800	26,200
1	7,600	9,200	11,500	15,300	19,100	22,900
1-1/4	6,100	7,300	9,200	12,200	15,300	18,300

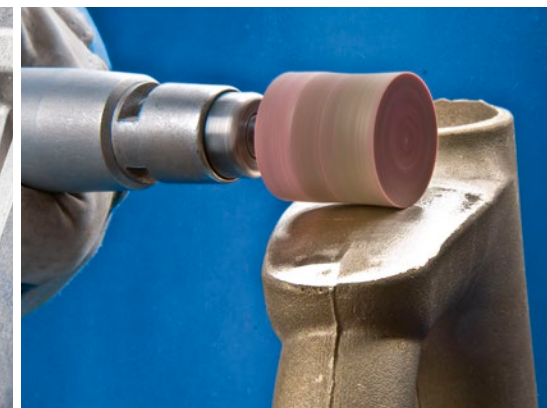

To make it easier to choose the right Poliflex® finishing point, we have designed our range around material groups, main areas of application and special operational requirements.

How do you find the best Poliflex® finishing point?

The table below shows which variations of abrasives and bonds are recommended for various materials. The differentiation of the selection criteria allows the user to find the best finishing point by material, application and surface finish. The bond and grain mixture have a large impact on the abrasive performance, service life and aggressiveness of the points. They also determine the look of the surface.

Choose your Poliflex® finishing point by:

- ① Material of component ② Type of application ③ Desired surface finish ④ Bond ⑤ Reference catalogue page for more information

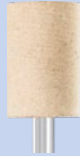
① Material group			② Application		Bond	Elastomer bond	
					Abrasive (grain mixtures)	AR	AW
							
					④ Designation/bond	GR	LR
					Recommended peripheral speed	2,000–2,400 SFPM	2,000–3,000 SFPM
					③ Surface finish		
Steel, cast steel	Non-hardened, non-heat-treated steels	Construction steels, carbon steels, tool steels, non-alloyed steels, case-hardened steels, tempering steels, cast steel	Surface grinding	Matte surface	○		
				Shiny surface	●	○	
			Edge grinding with high dimensional stability	Matte surface	○		
	Shiny surface						
	Hardened, heat-treated steels	Tool steels, tempering steels, alloyed steels, alloyed cast steel	Surface grinding	Matte surface	○		
				Shiny surface	○	●	
Edge grinding with high dimensional stability			Matte surface				
	Shiny surface						
Stainless steel (INOX)	Rust- and acid-resistant steels	Austenitic and ferritic stainless steels	Surface grinding	Matte surface			
				Shiny surface	●	○	
			Edge grinding with high dimensional stability	Matte surface			
				Shiny surface		○	
			General use		Structured surface		
			Non-ferrous metals	Soft non-ferrous metals, non-ferrous metals	Aluminum alloys, brass, copper, zinc	Surface grinding	Matte surface
Shiny surface	○	●					
Edge grinding with high dimensional stability	Matte surface						
	Shiny surface	○				●	
Hard non-ferrous metals	Bronze, titanium, titanium alloys, hard aluminum alloys	Surface grinding		Matte surface			
				Shiny surface	○		
		Edge grinding with high dimensional stability		Matte surface			
				Shiny surface			
High-temperature-resistant materials	Nickel-based and cobalt-based alloys	Surface grinding		Matte surface			
				Shiny surface	●		
		Edge grinding with high dimensional stability		Matte surface			
				Shiny surface			
● = highly recommended ○ = recommended					⑤ Catalogue page	110–111	112–113



Poliflex® finishing points

Rubber bond

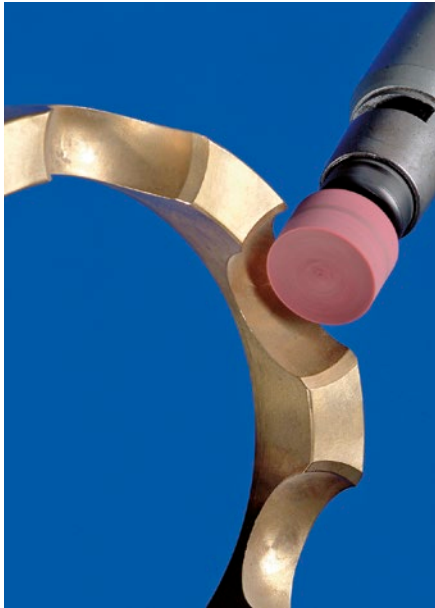

Poliflex® finishing points with the rubber bond are manufactured with pink aluminum oxide. The rubber (GR) bond is an elastomer-based soft bond. Ideal for use on surfaces.

Advantages:

- For achieving a fine, shiny surface finish.
- **Rubber bond:** Soft grinding due to soft, elastic bond.

Abrasive:

- White aluminum oxide AW

Applications:

- Step-by-step fine grinding

Compatible power tools:

- Flexible shaft drives
- Straight grinders

Recommendations for use:

- Depending on the application, profile with a diamond dresser or with ceramic dressing stones at a low rotational speed. Please refer to catalogue section 3 for detailed information and ordering data for dressing products.
- **Rubber bond:** For best performance, use with a recommended peripheral speed of 2,000–2,400 SFPM.

Safety notes:

- For safety reasons, the specified maximum permitted rotational speed must never be exceeded.
- The clamping length of the shank must be at least 1/2".

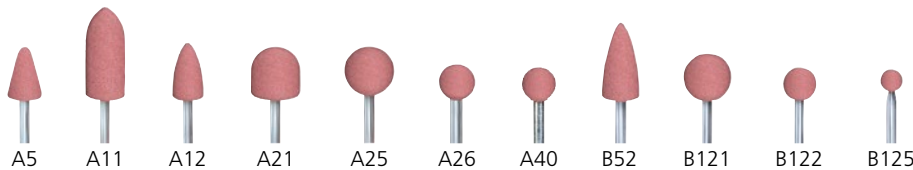

Series A and B

Finishing points available in a variety of shapes for fine grinding of small surfaces.

Dimensional specifications:

- D = Mounted point outer diameter
- T = Mounted point width
- S_d = Shank diameter
- L₂ = Shank length

PFERD designation:

GR

Shape	D [Inches]	T [Inches]	Grit	EDP number	Recom. RPM 1/2" overhang	Max. RPM 1/2" overhang	Max. RPM 1" overhang	
Shank diameter 1/8" x 1-1/4" [S_d x L₂]								
B122	3/8	3/8	120	36361	24,000	68,740	37,790	10
B125	1/4	1/4	120	36401	36,000	75,330	50,640	10
Shank diameter 1/4" x 1-1/2" [S_d x L₂]								
A5	3/4	1-1/8	120	36461	12,000	38,550	31,270	10
A11	7/8	2	120	36471	10,000	25,420	20,100	10
A12	11/16	1-1/4	120	36481	13,000	38,050	30,790	10
A21	1	1	120	36491	9,000	35,510	28,840	10
A25	1	1	120	36451	9,000	35,510	28,840	10
A26	5/8	5/8	120	36431	14,000	48,980	40,410	10
A40	3/4	3/4	120	36441	12,000	50,930	50,930	10
B52	3/8	3/4	120	36501	24,000	78,340	54,390	10
B121	1/2	1/2	120	36421	18,000	69,310	45,850	10

Series W

Finishing points in cylindrical shape, for fine grinding of small surfaces.

PFERD designation:

GR

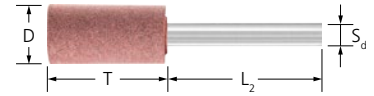

Shape	D [Inches]	T [Inches]	Grit	EDP number	Recom. RPM 1/2" overhang	Max. RPM 1/2" overhang	Max. RPM 1" overhang		
Shank diameter 1/8" x 1-1/4" [$S_d \times L_2$]									
W162	1/4	3/8	120	36101	36,000	67,210	44,040	10	
W168	5/16	5/16	120	36111	29,000	65,900	42,790	10	
W170	5/16	1/2	120	36121	29,000	54,860	34,040	10	
W174	3/8	1/4	120	36131	24,000	65,510	42,440	10	
W175	3/8	3/8	120	36141	24,000	57,530	35,990	10	
W176	3/8	5/8	120	36151	24,000	50,460	30,450	10	
W185	1/2	1/2	120	36171	18,000	42,750	24,370	10	
Shank diameter 1/4" x 1-1/2" [$S_d \times L_2$]									
W178	3/8	1	120	36191	24,000	40,360	30,780	10	
W193	5/8	3/8	120	36231	14,500	44,330	34,340	10	
W196	5/8	1	120	36251	14,500	34,670	25,340	10	
W204	3/4	3/4	120	36281	12,000	36,510	27,040	10	
W220	1	1	120	36311	9,000	30,370	21,410	10	
W230	1-1/4	1-1/4	120	36331	7,200	25,200	16,760	5	

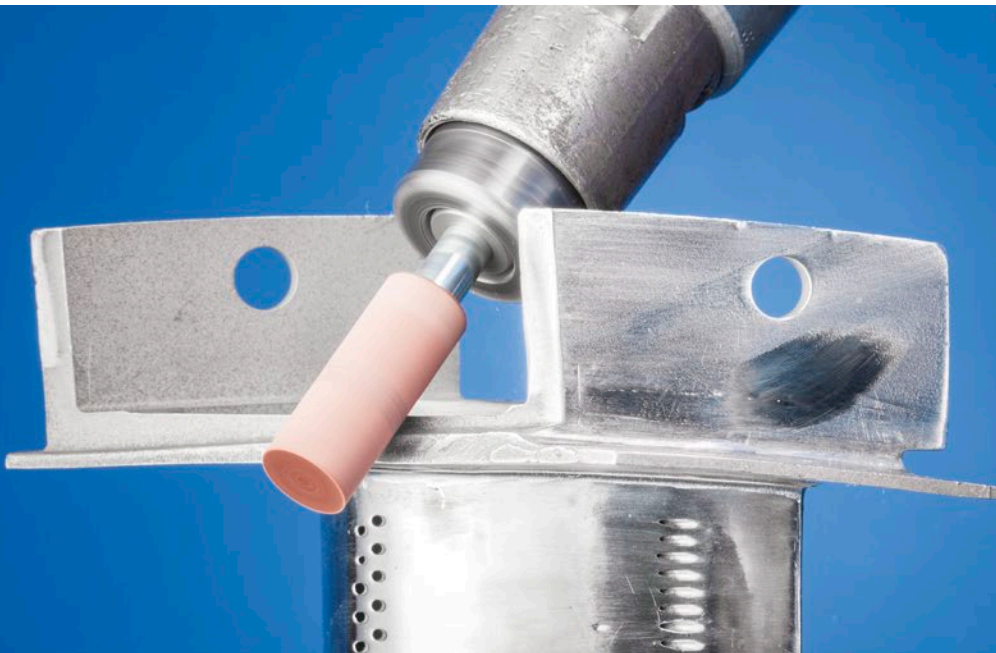

Poliflex® finishing points

Leather bond



Poliflex® finishing points with the leather bond are manufactured with white aluminum oxide. The leather (LR) bond is a hard, sturdy bond. Ideal for use on surfaces.

Advantages:

- For achieving a fine, shiny surface finish.
- High productivity due to long service life and very high stock removal rate.

Abrasive:

- Aluminum oxide A

Applications:

- Step-by-step fine grinding

Compatible power tools:

- Flexible shaft drives
- Straight grinders

Recommendations for use:

- Depending on the application, profile with a diamond dresser or with ceramic dressing stones at a low rotational speed. Please refer to catalogue section 3 for detailed information and ordering data for dressing products.

- **Leather bond:** For best performance, use with a recommended peripheral speed of 3,000–4,000 SFPM.

Safety notes:

- For safety reasons, the specified maximum permitted rotational speed must never be exceeded.
- The clamping length of the shank must be at least 1/2".

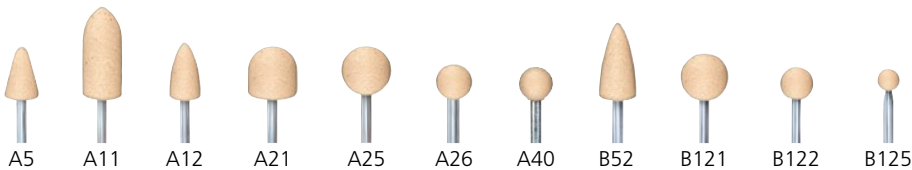

Series A and B

Finishing points available in a variety of shapes for fine grinding of small surfaces.

Dimensional specifications:

- D = Mounted point outer diameter
- T = Mounted point width
- S_d = Shank diameter
- L₂ = Shank length

PFERD designation:

LR

Shape	D [Inches]	T [Inches]	Grit	EDP number	Recom. RPM 1/2" overhang	Max. RPM 1/2" overhang	Max. RPM 1" overhang	
Shank diameter 1/8" x 1-1/4" [S_d x L₂]								
B122	3/8	3/8	120	36365	40,000	68,740	37,790	10
B125	5/16	5/16	120	36405	60,000	75,330	50,640	10
Shank diameter 1/4" x 1-1/2" [S_d x L₂]								
A5	3/4	1-1/8	120	36465	20,000	38,550	31,270	10
A11	7/8	2	120	36475	17,000	25,420	20,100	10
A12	11/16	1-1/4	120	36485	22,000	38,050	30,790	10
A21	1	1	120	36495	15,000	35,510	28,840	10
A25	1	1	120	36455	15,000	35,510	28,840	10
A26	5/8	5/8	120	36435	24,000	48,980	40,410	10
A40	3/4	3/4	120	36445	20,000	50,930	50,930	10
B52	3/8	3/4	120	36505	40,000	78,340	54,390	10
B121	1/2	1/2	120	36425	30,000	69,310	45,850	10

Series W

Fine finishing points in cylindrical shape, for fine grinding of small surfaces.

PFERD designation:

LR

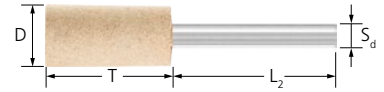

Shape	D [Inches]	T [Inches]	Grit	EDP number	Recom. RPM 1/2" overhang	Max. RPM 1/2" overhang	Max. RPM 1" overhang		
Shank diameter 1/8" x 1-1/4" [$S_d \times L_2$]									
W162	1/4	3/8	120	36105	60,000	67,210	44,040	10	
W168	5/16	5/16	120	36115	48,000	65,900	42,790	10	
W170	5/16	1/2	120	36125	48,000	54,860	34,040	10	
W174	3/8	1/4	120	36135	40,000	65,510	42,440	10	
W175	3/8	3/8	120	36145	40,000	57,530	35,990	10	
W176	3/8	5/8	120	36155	40,000	50,460	30,450	10	
W185	1/2	1/2	120	36175	30,000	42,750	24,370	10	
W186	1/2	3/4	120	36185	30,000	31,220	15,900	10	
Shank diameter 1/4" x 1-1/2" [$S_d \times L_2$]									
W178	3/8	1	120	36195	40,000	40,360	30,780	10	
W193	5/8	3/8	120	36235	24,000	44,330	34,340	10	
W196	5/8	1	120	36255	24,000	34,670	25,340	10	
W204	3/4	3/4	120	36285	24,000	36,510	27,040	10	
W206	3/4	1-1/4	120	36295	20,000	29,810	20,870	10	
W220	1	1	120	36315	15,000	30,370	21,410	10	
W230	1-1/4	1-1/4	120	36335	13,000	25,200	16,760	10	

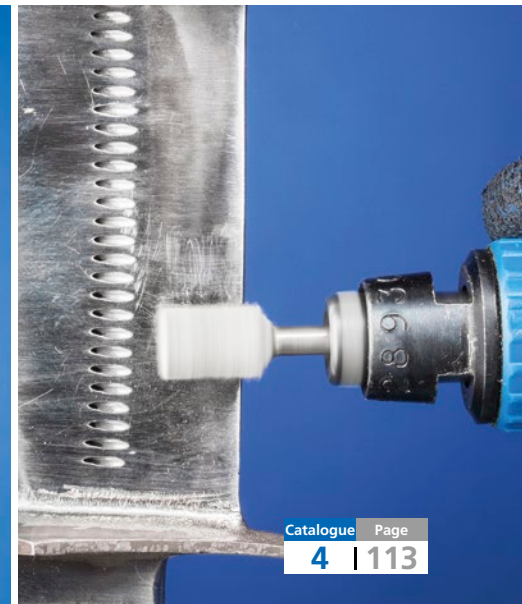
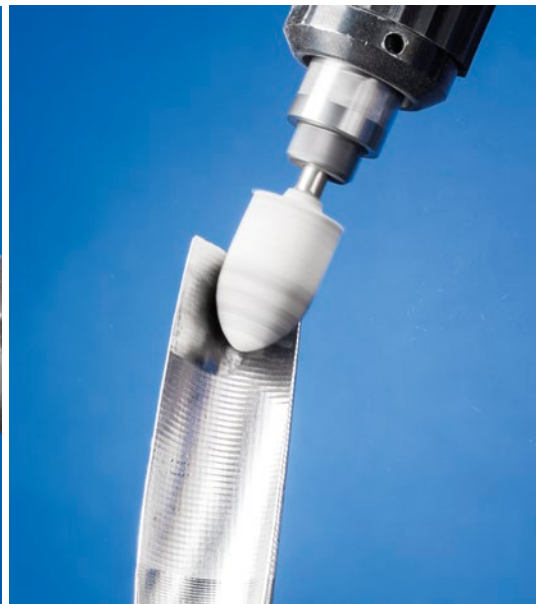
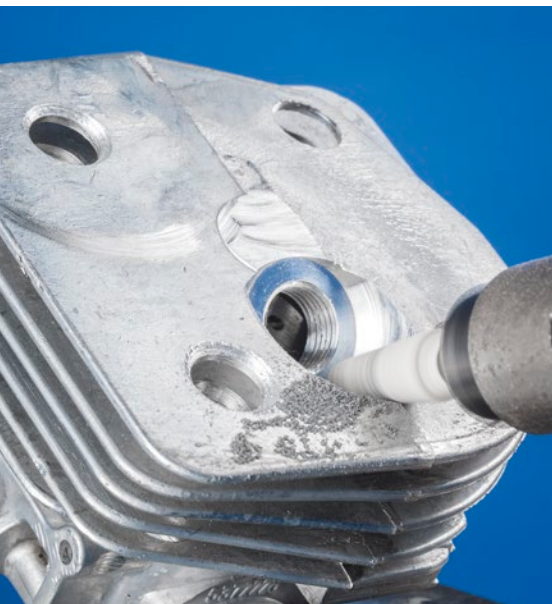

Poliflex® finishing wheels

General information – Textile wheels



Poliflex® wheels with the textile (TX) bond are manufactured with standard aluminium oxide. The textile fabric inlays make the TX bond a very hard, sturdy bond. Recommended for use on edges.

Advantages:

- For achieving a fine, matte surface finish.
- High profitability due to high abrasive performance and long service life.

Abrasive:

- Aluminum oxide A

Applications:

- Step-by-step fine grinding
- Surface grinding
- Weld removal
- Blending
- Deburring
- Edge grinding

Compatible power tools:

- Angle grinder
- Cordless angle grinder

Recommendations for use:

- Poliflex® textile wheels grind and finish in one operation.

Safety notes:

- For safety reasons, the specified maximum permitted rotational speed must never be exceeded.
- Poliflex® textile wheels perform best at a recommended peripheral speed of 6,000–9,800 SFPM.



Textile wheels



TX INOX + ALU

Textile wheels are cotton-fibre based abrasive products developed for medium to light grinding, weld blending, deburring and surface finishing of stainless steel and aluminum. Textile wheels grind and finish in one operation.

Workpiece materials:

stainless steel (INOX), aluminum

Applications:

surface grinding, weld removal, blending, deburring and edge grinding

Abrasive:

Aluminum oxide A

Pferd designation:

TX

Ordering notes:

U = thickness

D [Inches]	U [Inches]	H [Inches]	Grit and EDP number		Max. RPM	
			36	54		
Depressed centre (type 27) – plain arbor hole						
4-1/2	1/4	7/8	61433	61434	13,300	10
Depressed centre (type 27) – threaded arbor hole						
4-1/2	1/4	5/8-11	61442	61443	13,300	10

The comprehensive range of polishing products include:

- Felt points
- Mounted felt flap wheels
- Felt wheels
- Felt flap discs
- Cloth rings

Felt points and discs are predominantly used for high-gloss polishing.



Advantages:

- Felt points and discs: Precise retention of geometric shapes due to the hardness of these products.
- Felt flap discs, cloth rings and mounted felt flap wheels: Excellent adaptation to contours due to high flexibility.
- Can be freely shaped, meaning they can be used on complicated geometries.

Workpiece materials:

- Can be used on nearly all materials.

Applications:

- Polishing

Recommendations for use:

- For best performance, use with a recommended peripheral speed of 1,000–2,000 SFPM. This provides an ideal compromise between stock removal rate, surface quality, thermal load on the workpiece and service life.
- **Felt points and discs:**
Use diamond polishing pastes and polishing paste bars.
- **Cloth rings and mounted felt flap wheels:**
Use polishing and grinding pastes.
- When changing the polishing paste, use a brand-new polishing product.

Safety notes:

- For safety reasons, the specified maximum permitted rotational speed must never be exceeded.



Recommended rotational speed range

Example:

EDP 48520, Cylindrical shape, dia. 1/4"

Peripheral speed: 1,000–2,000 SFPM

Rotational speed: 15,300–30,600 RPM

Example:

EDP 48576, Conical pointed shape, dia. 3/4"

Peripheral speed: 2,000–3,000 SFPM

Rotational speed: 10,200–15,300 RPM

Polishing product dia. [Inches]	Peripheral speed [SFPM]					
	1,000	2,000	3,000	4,000	5,000	6,300
	Rotational speeds [RPM]					
1/4	15,300	30,600	45,800	61,100	76,400	96,300
5/16	12,200	24,400	36,700	48,900	61,100	77,000
3/8	10,200	20,400	30,600	40,700	50,900	64,200
1/2	7,600	15,300	22,900	30,600	38,200	48,100
9/16	6,800	13,600	20,400	27,200	34,000	42,800
3/4	5,100	10,200	15,300	20,400	25,500	32,100
1	3,800	7,600	11,500	15,300	19,100	24,100
1-1/4	2,500	5,100	7,600	10,200	12,700	16,000
2	1,900	3,800	5,700	7,600	9,600	12,000
2-1/4	1,600	3,200	4,800	6,400	8,000	10,100
3	1,300	2,500	3,800	5,100	6,400	8,000
4	1,000	1,900	2,900	3,800	4,800	6,000
4-1/2	800	1,700	2,500	3,400	4,200	5,300
5	800	1,500	2,300	3,100	3,800	4,800
6	600	1,300	1,900	2,500	3,200	4,000
8	500	1,000	1,400	1,900	2,400	3,000

Polishing products

Felt points

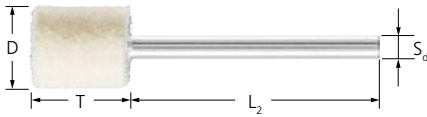

Cylindrical shape

Cylindrical shape points, primarily for peripheral use. Feature a centre hole to facilitate face-down polishing.

Compatible power tools:
flexible shaft drive, straight grinder

D [Inches]	T [Inches]	EDP number	Opt. RPM	Max. RPM	
Shank diameter 1/8" x 1-5/8" [S_d x L₂]					
1/4	3/8	48520	16,000–32,000	79,500	10
5/16	3/8	48521	12,000–24,000	59,500	10
3/8	9/16	48522	10,000–20,000	47,500	10
Shank diameter 1/4" x 1-5/8" [S_d x L₂]					
3/8	9/16	48523	10,000–20,000	47,500	10
9/16	3/4	48524	6,000–12,000	31,500	10
3/4	1	48525	5,000–10,000	23,500	10
1	1-1/4	48526	4,000–8,000	19,000	10

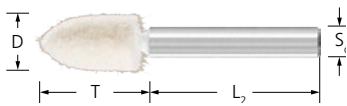

Conical pointed shape

The conical pointed shape is mainly used for work on radii and contours.

Compatible power tools:
flexible shaft drive, straight grinder

D [Inches]	T [Inches]	EDP number	Opt. RPM	Max. RPM	
Shank diameter 1/8" x 1-5/8" [S_d x L₂]					
5/16	1/2	48570	12,000–24,000	59,500	10
3/8	3/4	48571	10,000–20,000	47,500	10
1/2	3/4	48573	8,000–16,000	39,500	10
Shank diameter 1/4" x 1-5/8" [S_d x L₂]					
3/8	3/4	48572	10,000–20,000	47,500	10
9/16	3/4	48574	6,000–12,000	31,500	10
9/16	1-1/4	48575	6,000–12,000	31,500	10
3/4	1	48576	5,000–10,000	23,500	10



Conical shape with radius end

The conical shape is mainly used for work on radii.

Compatible power tools:
flexible shaft drive, straight grinder

D [Inches]	T [Inches]	EDP number	Opt. RPM	Max. RPM	
Shank diameter 1/4" x 1-5/8" [S_d x L₂]					
9/16	3/4	48600	6,000–12,000	31,500	10
3/4	1	48601	5,000–10,000	23,500	10
1	1-1/4	48602	4,000–8,000	19,000	10
1-1/4	1-3/8	48603	3,000–6,000	15,500	10

Cylindrical shape with radius end

The cylindrical shape with radius end is mainly used for work on small, concave contours.

Compatible power tools:
flexible shaft drive, straight grinder

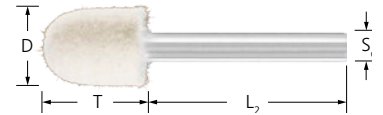

D [Inches]	T [Inches]	EDP number	Opt. RPM	Max. RPM	
Shank diameter 1/8" x 1-5/8" [S_d x L₂]					
5/16	1/2	48630	12,000–24,000	59,500	10
3/8	9/16	48631	10,000–20,000	47,500	10
Shank diameter 1/4" x 1-5/8" [S_d x L₂]					
9/16	3/4	48632	6,000–12,000	31,500	10
3/4	1	48633	5,000–10,000	23,500	10
1	1-1/4	48634	4,000–8,000	19,000	10

Mounted felt flap wheels

Mounted felt flap wheels

Mounted felt flap wheels are used for pre-polishing and high-gloss polishing on small to medium-sized components.

Advantages:

- Low thermal load on the workpiece.

Recommendations for use:

- Use the hard type for pre-polishing flat surfaces, and the soft type for high-gloss polishing and processing workpieces with lots of contours.
- If very fine finishes need to be achieved, the two types can be used successively.

Compatible power tools:

flexible shaft drive, straight grinder

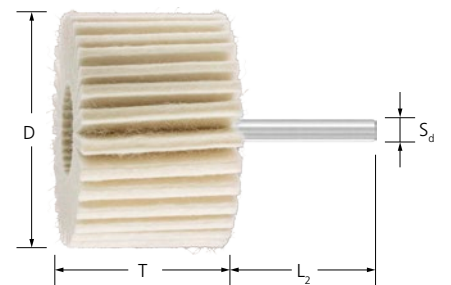

4



D [Inches]	T [Inches]	Type and EDP number		Opt. RPM	Max. RPM	
		W (soft)	H (hard)			
Shank diameter 1/4" x 1-1/2" [S_d x L₂]						
1	3/8	48540	48541	7,500	24,500	5
1	1	48542	48543	7,500	24,500	5
2	1	48546	48547	3,800	12,000	5
3	1	48550	48551	2,400	7,500	5
3	2	48552	48553	2,400	7,500	5



Polishing products

Felt wheels

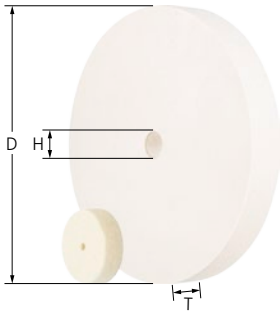

Felt wheels

Felt wheels are mainly used peripherally.

Compatible power tools:
flexible shaft drive, straight grinder

Ordering notes:

■ Please order the matching arbor separately.

D [Inches]	T [Inches]	H [Inches]	EDP number	Opt. RPM	Max. RPM	Recommended arbors	
1-1/4	1/4	1/4	48690	3,000–6,000	20,000	69029	5
1-3/4	3/8	1/4	48691	2,000–4,000	13,500	69029	5
2-1/4	3/8	1/4	48692	1,500–3,000	10,000	69029	5
3	3/8	3/8	48693	1,000–2,000	7,500	69027	5
4	3/4	3/8	48695	900–1,800	6,100	69031	1
5	3/4	3/4	48697	750–1,500	4,900	69032	1
6	1	3/4	48699	600–1,200	4,000	69032	1
8	1-1/4	3/4	48700	500–1,000	3,000	69032	1

Felt flap discs



Felt flap discs

Felt flap discs are used for pre-polishing and high-gloss polishing on medium-sized to large components.

Advantages:

■ Low thermal load on the workpiece.

Recommendations for use:

- Use the hard type for pre-polishing flat surfaces, and the soft type for high-gloss polishing and processing workpieces with many contours.
- If very fine finishes need to be achieved, the two types can be used successively.

Compatible power tools:

angle grinder, cordless angle grinder

Ordering notes:

T = thickness

D [Inches]	T [Inches]	H [Inches]	Type and EDP number		Opt. RPM	Max. RPM	
			W (soft)	H (hard)			
4-1/2	7/8	7/8	48802	48803	1,650	8,350	5
5	7/8	7/8	48804	48805	1,500	7,650	5

Cloth rings

Cloth rings are used for pre-polishing and high-gloss polishing with polishing pastes. If the intention is to achieve very smooth surface finishes, use several or even all variants successively.

Cloth rings are available in four types:

- ST (sisal cloth) = Coarse pre-polishing
- TH (hard cloth) = Pre-polishing
- TW (soft cloth) = High-gloss polishing
- FL (flannel) = High-gloss polishing/buffing

Recommendations for use:

- Pre-polishing of steel and INOX: Cloth rings ST or TH with green polishing paste.
- Pre-polishing of aluminum and brass: Cloth rings ST or TH with grey polishing paste.
- Pre-polishing of non-ferrous metals: Cloth rings ST or TH with brown polishing paste.
- High-gloss polishing on all metals: Cloth rings TW or FL with pink polishing paste.
- High-gloss polishing on plastics: Cloth rings TW or FL with beige polishing paste.
- Type TW and FL cloth rings achieve their best performance at a recommended peripheral speed of 1,000–3,000 SFPM.
- Type ST and TH cloth rings achieve their best performance at a recommended peripheral speed of 2,000–3,000 SFPM.

Compatible power tools:
flexible shaft drive, straight grinder

Ordering notes:
■ Please order arbor separately.



D [Inches]	H [Inches]	Face width [Inches]		Type and EDP number				Opt. RPM	Max. RPM	Recommended arbors		
		Sisal	Hard, soft and flannel	ST	TH	TW	FL			Sisal	Hard, soft and flannel	
3	3/8	3/4	3/8	48710	48720	48730	48740	2,500	7,500	69027	69027	5
4	3/8	3/4	3/8	48711	48721	48731	48741	1,900	6,100	69027	69027	5
6	3/4	1	3/8	48713	48723	48733	48743	1,250	4,000	69032	69032	5
8	3/4	1	3/8	48714	48724	48734	48744	950	3,000	69032	-	5

Drive arbors for cloth rings

Matching arbors for felt wheels and cloth rings.

Advantages:

- Increased economic efficiency due to quick product changes.

EDP 69029



EDP 84656



EDP 69027



EDP 69032



Fits arbor hole size [Inches]	S [Inches]	L [Inches]	Clamping width [Inches]	EDP number	
1/4	1/4	7/8	3/16–3/4	69029	1
3/8	1/4	7/8	0–5/16	69027	1
1/2, 5/8	1/4	3/4	1/8–1/2	84656	1
1/2, 3/4	3/8	1	1/4–1	69032	1



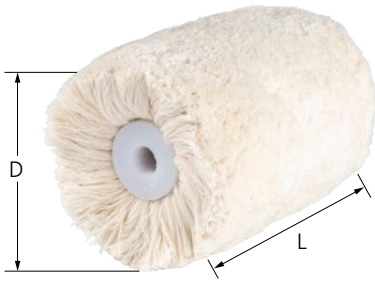

Buffing drum

Buffing drum is made from densely packed soft cotton yarn and is used for high-gloss polishing with polishing pastes. Numerous string ends hold buffing compounds and high pliability enables finishes on irregular surfaces.

Advantages:

- Extremely flexible for polishing contours.
- Quickly achieves a polished surface.

Recommendations for use:

- Use a sufficient amount of polishing paste to achieve a polished finish.

Compatible power tools:

drum grinder

Ordering notes:

- Additional drum products can be found on pages 45, 78, 100 and 101, as well as in catalogue section 8.
- Refer to our "Power tools" catalogue section 9 for information on the linear finishing tool, EDP 91217.

D [Inches]	L [Inches]	Thread [Inches]	EDP number	Opt. RPM	Max. RPM	
4	4	5/8-11	48842	3,500	3,500	1



PFERD offers grinding pastes for use in extremely fine grinding work, such as when grinding in valve seats, shaft bearings and as a preparation for polishing with felt polishing products and cloth rings.

PFERD offers five different polishing paste bars that are clearly marked with different colours to easily identify the respective application task. You can find the key for the respective colours in the table below.



Advantages:

- High productivity.
- Quick results.
- Coordinated system.

Workpiece materials:

- Can be used on nearly all materials.

Applications:

- Polishing
- Step-by-step fine grinding

Grinding pastes

Oil-soluble grinding pastes with sharp-edged SiC grain.



Grit size	EDP number	Contents		Box icon
		[oz]	[grams]	
90	48770	8.82	250	1
150	48771	8.82	250	1
280	48772	8.82	250	1
360	48773	8.82	250	1
600	48774	8.82	250	1
800	48775	8.82	250	1

Polishing paste bars

Apart from being used with felt products, polishing pastes are also used in combination with cloth rings and buffing drums for pre-polishing and high-gloss polishing. If the intention is to achieve very smooth surface finishes, use several or even all types successively.

Intended applications for the different types:

- ST (sisal cloth) = Coarse pre-polishing with green, grey, or brown pastes
- TH (hard cloth) = Pre-polishing with green, grey, or brown pastes
- TW (soft cloth) = High-gloss polishing with pink or beige pastes
- FL (flannel) = High-gloss polishing/buffing with pink or beige pastes

Polishing paste bars are available in a small pack and bulk packs.

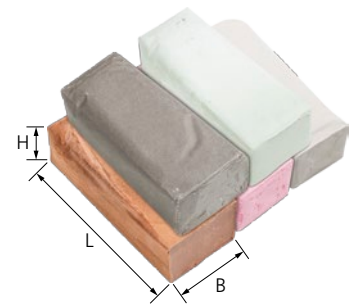

Type	Use for	EDP number	Contents		Colour	B [Inches]	H [Inches]	L [Inches]	Box icon	
			[oz]	[grams]						
Bulk pack	pre-polishing	Steel + stainless steel (INOX)	48760	38.8	1,100	green	2-3/4	2	5-1/2	1
		Aluminum + brass	48761	45.8	1,300	grey	2-3/4	2	5-1/2	1
		Non-ferrous metals	48762	40.5	1,150	brown	2-3/4	2	5-1/2	1
high-gloss polishing		All metals	48763	40.5	1,150	pink	2-3/4	2	5-1/2	1
		plastics	48764	38.8	1,100	beige	2-3/4	2	5-1/2	1
Small pack	pre-polishing	Steel + stainless steel (INOX)	48765	3.8	108	green	1	1-1/4	3-1/2	1
		Aluminum + brass	48766	5.0	142	grey	1	1-1/4	3-1/2	1
		Non-ferrous metals	48767	3.9	111	brown	1	1-1/4	3-1/2	1
high-gloss polishing		All metals	48768	4.7	132	pink	1	1-1/4	3-1/2	1
		plastics	48769	3.6	104	beige	1	1-1/4	3-1/2	1

Grinding and polishing pastes

Diamond polishing pastes



Diamond polishing pastes are used for work on hard materials, such as tungsten carbide and hardened steels. They are used in combination with felt polishing elements. Diamond polishing pastes can be diluted and dissolved with water and alcohol.

Available grit sizes:
 30 (coarse) = P 500
 15 (medium) = P 1200
 10 (medium-fine) = P 2000
 7 (fine) = P 3000
 3 (very fine) = P 5000
 1 (ultra-fine) = P 14000
 (P = Grit size according to ISO 6344)

Advantages:

- High productivity.
- Quick results.
- Precisely coordinated granulation rows.

Workpiece materials:

- Can be used on almost all hard materials, such as tungsten carbide and hardened steels.

Applications:

- Polishing
- Step-by-step fine grinding

Ordering notes:

- The grit sizes are specified in μm .



Diamond polishing pastes

Diamond polishing pastes guarantee quick and efficient work, particularly in tool and die making.

Recommendations for use:

- When using diamond polishing pastes, use the coarse paste first.
- If extensive surface improvements are required, use several grit sizes one after another, each finer than the previous, cleaning well between pastes.
- When changing grit size, make sure that a new, clean polishing product (e.g. felt point or felt wheel) is used.

Grit size [μm]	EDP number	Contents		Colour of sealing cap	
		[oz]	[grams]		
30	48799	0.35	10	brown	1
15	48798	0.35	10	blue	1
10	48797	0.35	10	light blue	1
7	48796	0.35	10	red	1
3	48795	0.35	10	green	1
1	48794	0.35	10	yellow	1

Highly effective cleaners and maintenance products that can be applied to a very wide range of components.

Workpiece materials:

- Can be used on nearly all materials.

Applications:

- Cleaning
- Preserving
- Protecting



Universal cleaner

Highly effective, universal workshop cleaner for cleaning and de-greasing components as a preparation for painting. Removes polishing paste residue, processing oils, corrosion-protection oils, light waxes and other types of contamination.

Advantages:

- Biodegradable surfactants.
- Short drying time.
- Non-combustible.
- Appropriate for multi-purpose use.

Recommendations for use:

- Spray, briefly leave on, and wipe off with a cloth.



Contents		EDP number	
[fl oz]	[ml]		
16.9	500	48747	1

INOX SHINER maintenance product

Maintenance product for protecting and caring for stainless steel (INOX), aluminum, non-ferrous metals, glass and plastic. Removes dust, fingerprints, oil and light scale deposits.

Advantages:

- Leaves a dry, glossy protective film.
- Very easy to use.
- No cleaning marks.
- Appropriate for multi-purpose use.

Recommendations for use:

- Spray, apply evenly on the surface with a soft dry cloth or paper towel and wipe dry.
- Conduct a compatibility test beforehand on surfaces with a mirror finish.



Contents		EDP number	
[fl oz]	[ml]		
16.9	500	48748	1



X-LOCK quick-change system

General information



With the BOSCH X-LOCK system for angle grinders, you can change discs quickly and comfortably. Instead of a round centre hole, the X-LOCK system features an X-shaped contour, which allows the disc to be fixed on the angle grinder in a form-fitting manner. This guarantees that different discs can be mounted securely and comfortably in the shortest possible time. The unique system meets the highest quality and safety standards and even withstands tough and challenging operating conditions.

Advantages:

- Quick and comfortable disc changes.
- Discs are fixed securely since they audibly click into place.
- X-LOCK products can also be used on conventional angle grinders with 5/8-11 thread.

Recommendations for use:

- Place the disc on the X-LOCK quick-change system of your angle grinder and secure it by lightly pressing it down. The disc will audibly click into place.



How it works:



Place the disc on the X-LOCK holder in a form-fitting manner.



Lightly press the disc down until it audibly clicks into place.

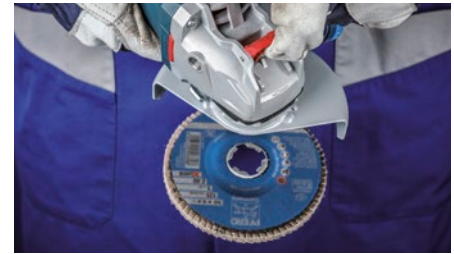

Release the disc by using the lever.

POLIVLIES® with X-LOCK quick-change system



Aluminum oxide A

For universal coarse to fine grinding applications in industry and professional trades.

Abrasive:

Aluminum oxide A
Available POLIVLIES® grit sizes:
100 C = coarse (yellow-brown)
180 M = medium (red-brown)
240 F = fine (blue)

Recommendations for use:

- For the best results, use at a recommended peripheral speed of 6,000–6,900 SFPM.

Notes:

- For more information on POLIVLIES® flap discs, see page 103.

D [Inches]	T [Inches]	H [Inches]	Grit, type and EDP number			Opt. RPM	Max. RPM	
			100 C	180 M	240 F			
X-LOCK								
4-1/2	3/4	X-LOCK (7/8)	43303	43304	43305	5,000–5,800	13,300	5
5	3/4	X-LOCK (7/8)	43306	43307	43308	4,600–5,300	12,200	5

Subject to technical modifications.

06/2019

Printed in U.S.A.

820 904